



▶ User Guide for the Polycom®  
SoundPoint IP® 32x/33x Phone

---

## Trademark Information

POLYCOM®, the Polycom “Triangles” logo and the names and marks associated with Polycom’s products are trademarks and/or service marks of Polycom, Inc. and are registered and/or common law marks in the United States and various other countries. All other trademarks are property of their respective owners. No portion hereof may be reproduced or transmitted in any form or by any means, for any purpose other than the recipient’s personal use, without the express written permission of Polycom.

## Patent Information

The accompanying product is protected by one or more U.S. and foreign patents and/or pending patent applications held by Polycom, Inc.

## Disclaimer

Some countries, states, or provinces do not allow the exclusion or limitation of implied warranties or the limitation of incidental or consequential damages for certain products supplied to consumers, or the limitation of liability for personal injury, so the above limitations and exclusions may be limited in their application to you. When the implied warranties are not allowed to be excluded in their entirety, they will be limited to the duration of the applicable written warranty. This warranty gives you specific legal rights which may vary depending on local law.

## Copyright Notice

Portions of the software contained in this product are:

Copyright © 1998, 1999, 2000 Thai Open Source Software Center Ltd. and Clark Cooper

Copyright © 1998 by the Massachusetts Institute of Technology

Copyright © 1998-2003 The OpenSSL Project

Copyright © 1995-1998 Eric Young (eay@cryptsoft.com). All rights reserved

Copyright © 1995-2002 Jean-Loup Gailly and Mark Adler

Copyright © 1996-2004, Daniel Stenberg, <daniel@haxx.se>

Permission is hereby granted, free of charge, to any person obtaining a copy of this software and associated documentation files (the “Software”), to deal in the Software without restriction, including without limitation the rights to use, copy, modify, merge, publish, distribute, sublicense, and/or sell copies of the Software, and to permit persons to whom the Software is furnished to do so, subject to the following conditions:

The above copyright notice and this permission notice shall be included in all copies or substantial portions of the Software.

THE SOFTWARE IS PROVIDED “AS IS”, WITHOUT WARRANTY OF ANY KIND, EXPRESS OR IMPLIED, INCLUDING BUT NOT LIMITED TO THE WARRANTIES OF MERCHANTABILITY, FITNESS FOR A PARTICULAR PURPOSE AND NONINFRINGEMENT. IN NO EVENT SHALL THE AUTHORS OR COPYRIGHT HOLDERS BE LIABLE FOR ANY CLAIM, DAMAGES OR OTHER LIABILITY, WHETHER IN AN ACTION OF CONTRACT, TORT OR OTHERWISE, ARISING FROM, OUT OF OR IN CONNECTION WITH THE SOFTWARE OR THE USE OR OTHER DEALINGS IN THE SOFTWARE.

© 2010 Polycom, Inc. All rights reserved.

Polycom, Inc.

4750 Willow Road

Pleasanton, CA 94588-2708

USA

No part of this document may be reproduced or transmitted in any form or by any means, electronic or mechanical, for any purpose, without the express written permission of Polycom, Inc. Under the law, reproducing includes translating into another language or format.

As between the parties, Polycom, Inc., retains title to and ownership of all proprietary rights with respect to the software contained within its products. The software is protected by United States copyright laws and international treaty provision. Therefore, you must treat the software like any other copyrighted material (e.g., a book or sound recording). Every effort has been made to ensure that the information in this manual is accurate. Polycom, Inc., is not responsible for printing or clerical errors. Information in this document is subject to change without notice.

---

# About This Guide

Thank you for choosing the SoundPoint IP 32x/33x SIP, a full-duplex, hands-free phone. This unit provides business telephony features and functions such as multiple call appearances, call hold, transfer, and conference over an IP network.

This User Guide provides everything you need to quickly use your new phone. Verify with your system administrator that the network is prepared for configuring your SoundPoint IP 32x/33x SIP phone. As well, read the [Parts List](#) and [Regulatory Notices](#) sections in this guide before you set up and use the SoundPoint IP 32x/33x SIP phone. This information can also be found at <http://www.polycom.com/support/voip/>

## Changes to this Guide

Major updates have occurred to the following sections since the previous edition:

- [Connecting the Handset and Optional Headset](#) on page 1-5

The following section is new for this edition:

- [Backlight Intensity](#) on page 2-3



---

# Contents

<b>About This Guide</b> .....	<b>iii</b>
Changes to this Guide .....	iii
<b>1 Getting Started with Your SoundPoint IP 32x/33x Phone</b> ..	<b>1-1</b>
Parts List .....	1-2
Assembling Your SoundPoint IP 32x/33x Phone .....	1-3
Connecting Network and Power Source .....	1-4
Connecting the Handset and Optional Headset .....	1-5
Attaching the Base .....	1-6
Registering the Phone .....	1-8
Features of Your SoundPoint IP 32x/33x Phone .....	1-9
Before You Use Your SoundPoint IP 32x/33x Phone .....	1-12
<b>2 Customizing Your SoundPoint IP 32x/33x Phone</b> .....	<b>2-1</b>
Configuring Basic Settings .....	2-2
Appearance of Time and Date .....	2-2
Display Contrast .....	2-3
Backlight Intensity .....	2-3
Headset Memory Mode .....	2-6
Electronic Hookswitch .....	2-6
Ring Type .....	2-7
Language Support .....	2-8
Directory Search .....	2-8
Muting the Microphone .....	2-9
Adjusting the Volume .....	2-9
Managing Call Lists .....	2-10
Managing Contacts .....	2-11
Adding Contacts .....	2-11
Editing Contacts .....	2-15
Deleting Contacts .....	2-16

Placing a Call to a Contact .....	2-16
Searching For a Contact .....	2-17
Managing Incoming Calls .....	2-19
Distinguishing Calls .....	2-19
Rejecting Calls .....	2-19
Diverting Calls .....	2-20
System Customizations .....	2-21
Supporting Multiple Lines .....	2-21
Supporting Multiple Line Keys Per Line .....	2-22
Supporting Shared Lines .....	2-22

### **3 Using the Basic Features of Your SoundPoint IP 32x/33x Phone ..... 3-1**

Placing a Call .....	3-2
Answering a Call .....	3-4
Ending a Call .....	3-7
Redialing .....	3-8
Placing a Call on Hold .....	3-8
Setting Up Conferences .....	3-9
Transferring Calls .....	3-10
Forwarding Calls .....	3-12
Enabling Do Not Disturb .....	3-14
Assigning Speed Dial Indexes .....	3-14
Using Voice Mail .....	3-16

### **4 Using the Advanced Features of Your SoundPoint IP 32x/33x Phone ..... 4-1**

SIP-B Automatic Call Distribution .....	4-1
Using Multiple Call Appearances .....	4-3
Using Buddy Lists .....	4-5
Presence .....	4-5
Managing Buddies .....	4-5
Integrating With Microsoft Live Communications Server 2005 ....	4-7
Restarting Your Phone .....	4-8

### **5 Troubleshooting Your SoundPoint IP 32x/33x Phone ..... 5-1**

Power and Startup .....	5-2
Controls .....	5-3

Access to Screens and Systems ..... 5-4  
Calling ..... 5-5  
Displays ..... 5-7  
Audio ..... 5-8  
Productivity Suite ..... 5-8  
Testing Phone Hardware ..... 5-8

**Regulatory Notices .....Regulatory Notices-1**

**Index .....Index-1**

**End-User License Agreement for Polycom® Software .. EULA-1**





---

# Getting Started with Your SoundPoint IP 32x/33x Phone

This chapter provides basic installation instructions and information for obtaining the best performance with the SoundPoint IP 32x/33x (SoundPoint IP 320, 321, 330, 331, or 335) phone.

The SoundPoint IP 32x/33x provides a powerful, yet flexible IP communications solution, delivering excellent voice quality. The graphic display supplies content for call information, multiple languages, directory access, and system status. The SoundPoint IP 32x/33x supports advanced functionality, including multiple call and flexible line appearances, presence, custom ring tones, local conferencing, HTTPS secure provisioning, and Polycom's superb voice quality. The SoundPoint IP 335 uses Polycom® HD™ Voice technology.

This chapter contains:

- [Parts List](#)
- [Assembling Your SoundPoint IP 32x/33x Phone](#)
- [Features of Your SoundPoint IP 32x/33x Phone](#)
- [Before You Use Your SoundPoint IP 32x/33x Phone](#)

To customize your phone, refer to [Customizing Your SoundPoint IP 32x/33x Phone](#) on page 1-1. To read about the phone's basic features, refer to [Using the Basic Features of Your SoundPoint IP 32x/33x Phone](#) on page 3-1. To read about the phone's advanced features, refer to [Using the Advanced Features of Your SoundPoint IP 32x/33x Phone](#) on page 4-1.

If you require additional information or assistance with your new phone, contact your system administrator.

## Parts List

The following components are included in your SoundPoint IP 32x/33x package:

- Polycom SoundPoint IP 32x/33x phone

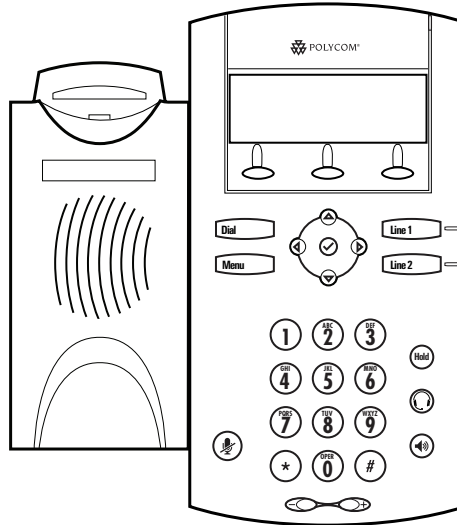

- Handset and Handset Cord

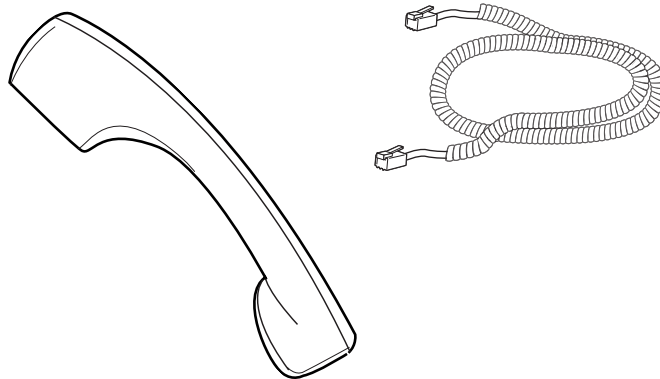

- Phone Base

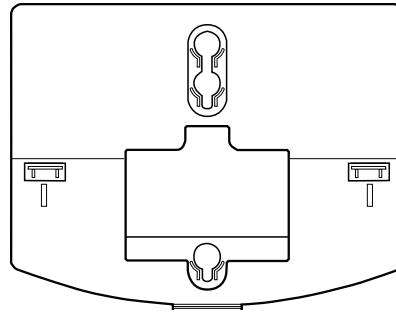

- Network / Power Cable

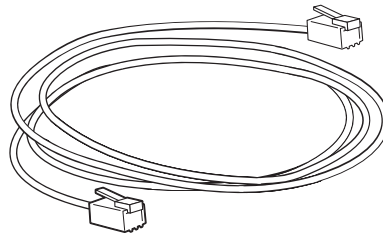

- Quick Start Guide and registration card

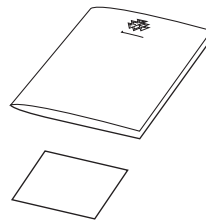

Ensure that you have received each item. If you are missing any items, contact your system administrator.

## Assembling Your SoundPoint IP 32x/33x Phone

This section describes how to assemble your SoundPoint IP 32x/33x phone. Topics include:

- Connect network and power source
- Connect handset and headset (optional)
- Attach phone base

If your phone is already assembled, go to [Features of Your SoundPoint IP 32x/33x Phone](#) on page 1-9.

## Connecting Network and Power Source

Use Power over Ethernet (PoE) for network and power source connections unless otherwise directed by your system administrator.

### Note

The AC power adapter is a separate, optional accessory. Your system administrator will provide one if necessary.

### Power over Ethernet

Using a regular CAT5 cable (optional accessory from Polycom), the phone can be powered from a PoE (IEEE 802.3af) compliant switch or hub.

### To connect using a PoE source:

- Plug the supplied network cable between the LAN jack on the phone and an available power and data port on the in-line power switch.

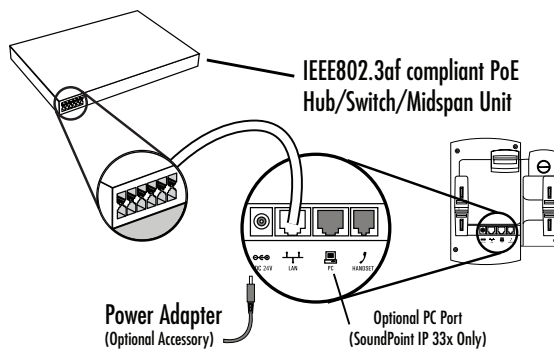

### Note

The SoundPoint IP 33x phones have an optional PC connection. The SoundPoint IP 32x phones do not.

If you want to use the optional PC connection on the SoundPoint IP 33x, a separate ferrite clamp (not included) is required. Contact your system administrator.

## Connecting the Handset and Optional Headset

### To connect the handset and optional headset:

1. Connect the short straight end of the phone cord to the handset and the corresponding longer straight end of the cord to the handset jack on the back of the phone

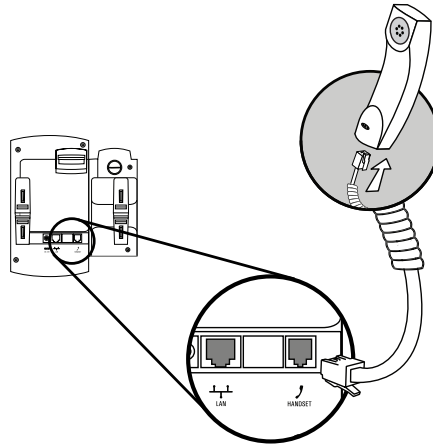

2. Connect the headset (optional) to the headset jack on the back of the phone.

#### SoundPoint IP 320, 321, 330 and 331:

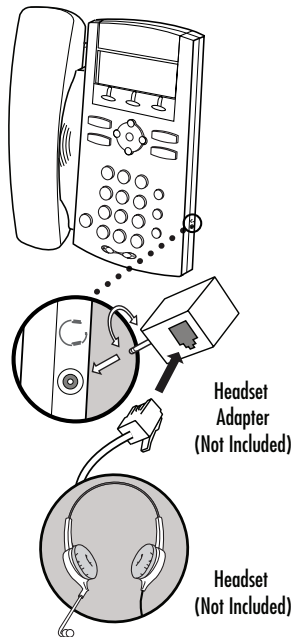

#### SoundPoint IP 335:

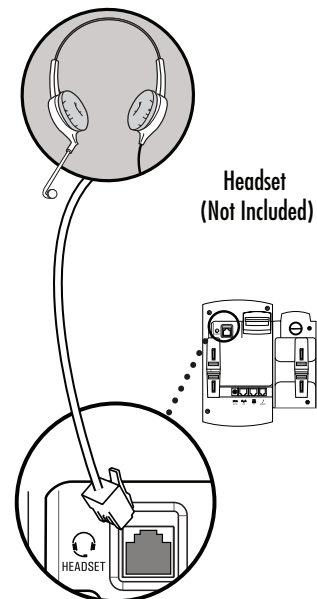



For information on supported headsets, go to [www.polycom.com/support/voice/soundpoint\\_ip/VoIP\\_Technical\\_Bulletins\\_pub.html](http://www.polycom.com/support/voice/soundpoint_ip/VoIP_Technical_Bulletins_pub.html) and look for “Technical Bulletin 37477: Headset Compatibility List”.

**Note**

For headsets terminated in RJ-9 modular jacks to be used with SoundPoint IP 320, 321, 330, and 331 phones, a separate Headset Jack Adapter (P/N 2457-11095-001) is required. To purchase the Headset Jack Adapter, contact your reseller.

Plug the headset RJ9 jack into the adapter, and then plug the adapter into the 2.5mm port on the right side of the phone as shown below. The headset operates as before.

**Note**

If headsets are deployed in high static environments where users frequently disconnect and re-connect the headset to the phone, it is possible that the phone can be damaged by electrostatic discharge (ESD).

You should take precautions to avoid excessive static buildup in your environment. This can include humidity control and removal of synthetic materials near the phone location. Antistatic spray applied to carpets in the workplace can reduce the level of static buildup.

## Attaching the Base

Attach the phone base to the phone in one of the following ways:

- As a desk mount
- As a wall mount

For more detailed instructions, go to <http://www.polycom.com/support/voip/> and search for the “Wallmount Instructions for SoundPoint IP Phones” quick tip.

**To attach the base as a desk mount:**

1. Place all cords in the recessed area above the modular jacks.

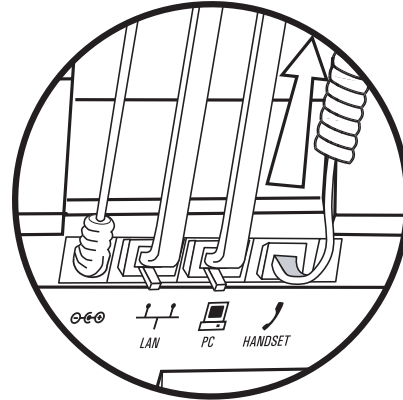

2. Align the protrusions on the bracket with their corresponding holes in the phone.

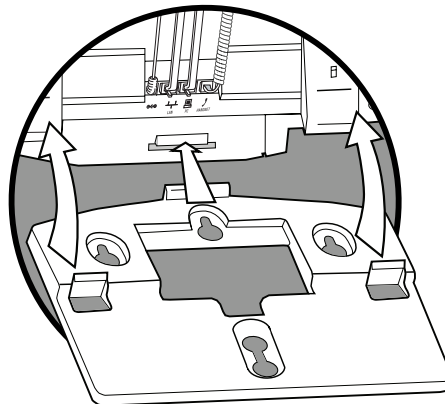

3. Snap them together to lock the bracket to the phone.



**To attach the base as a wall mount:**

1. Place all cords in the recessed area below the modular jacks.
2. On the back of the phone, remove the key located behind the hook switch and reposition it so that the end tab (at a 45° angle) is facing up.

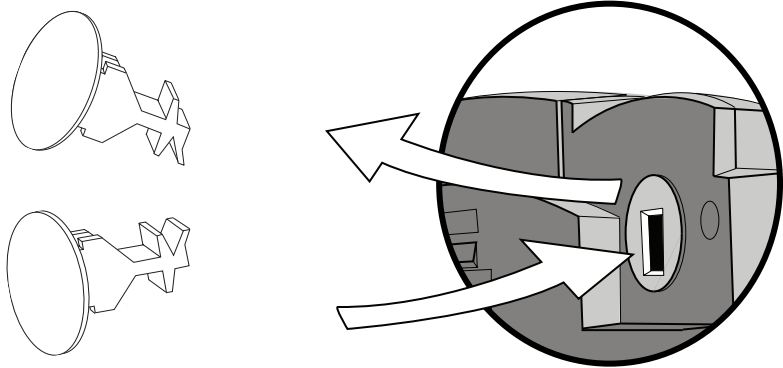

3. Using wall anchors (not included), fasten the base stand with the mounting tab facing up.
4. Align the base stand tabs with their corresponding insertion points on the phone, and then snap the phone into place (as shown).



## Registering the Phone

Generally, your phone will be deployed with multiple other phones. In this case, your system administrator will configure the phone parameters beforehand, so that after you set up your phone, the phone will be registered and ready to use.







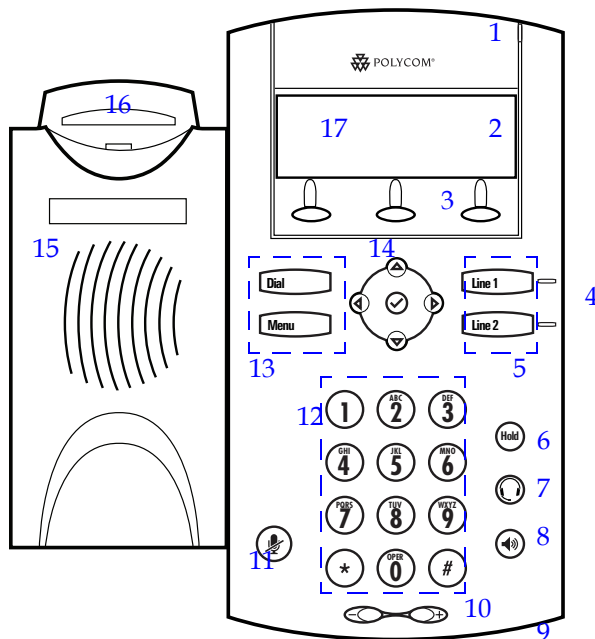





If your phone is not part of a large phone deployment, your phone may not be registered after you set it up. Before you use your phone, you or your system administrator will have to register it. For detailed information on how to register your phone after you install it, see *Quick Tip 44011: Register Standalone SoundPoint® IP, SoundStation® IP, and Polycom® VVX™ 1500 Phones* available at [http://www.polycom.com/usa/en/support/voice/soundpoint\\_ip/VoIP\\_Technical\\_Bulletins\\_pub.html](http://www.polycom.com/usa/en/support/voice/soundpoint_ip/VoIP_Technical_Bulletins_pub.html)

## Features of Your SoundPoint IP 32x/33x Phone

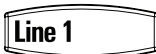
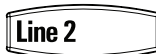

The features of the SoundPoint IP 32x/33x phone are:

1. **Message Waiting Indicator**—This will alert you to voice and text (instant) messages.
2. **Line Icons**—Use these keys to activate up to lines that can be assigned to your phone. The associated icons represent:
  - Registered line
  - Registered shared line
  - Unregistered line
  - VoiceMail/Messages





- Speed-Dial
  - Ringing 
  - Call in progress/Conference
  - Call Forward 
  - Do Not Disturb 
  - Presence/BLF 
3. **Soft Keys** – The screen will display labels for these keys, to identify their context-sensitive functions.
  4. **Line Indicators** – Individual multi-color LEDs display the dynamic call state and remote user status (busy lamp field (BLF) and presence). The LED's indicate the following:
    - Solid green – An active call is in progress.
    - Fast flashing green – There is an Incoming (ringing) call.
    - Flashing green – The call is held by the other party.
    - Flashing red – The call is on hold.
    - Solid red – The line is busy remotely (shared lines).
  5. **Line Keys**  and  – Activate up to two lines that can be assigned to your phone.
  6. **Hold**  – Holds an active call or resumes a held call.
  7. **Headset**  – Allows you to place and receive calls through an optionally connected headset.
  8. **Speakerphone**  – Allows for hands-free communication during calls.
  9. **Hands-free Microphone** – Picks up audio during hands-free calls. Place your phone on a hard, flat surface for best results.
  10. **Volume Keys**  – Adjusts the volume of the handset, headset, speaker, and ringer.
  11. **Microphone Mute**  – Mutes local audio during calls.

**12. Dial Pad** – Provides the 10 digits, alphabetic characters, and special characters available in context-sensitive applications.

**13. Feature Keys** – Access important features using these keys.

–  – Dials phone numbers or allows you to view the placed call list.

–  – Accesses local (your phone) and call server features.

**14. Display Control Keys** – Use , , , and  (arrow keys) to scroll through the displayed information.

Use  (the Select key) to select a field of displayed data or enter edit mode for some settings.

**15. Speaker** – For ringer and hands-free audio output.

**16. Hookswitch**



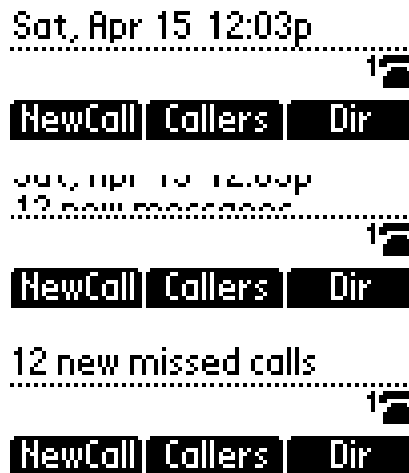

**17. Graphic Display** – Shows information about calls, messages, soft keys, time, date, and other relevant data.

– Important messages appear on the idle display through an animated scrolling list, which has precedence over the idle display. The following figures show a phone with four messages. The messages continuously scroll over the screen.



## Before You Use Your SoundPoint IP 32x/33x Phone





To navigate through menus and to enter data, these are useful tips:

- Press  to enter the basic settings menu or exit from any menu.
- Press  and  or hold  and  down to scroll through the lists.

### Note

Press the \* key to page up. Press the # key to page down. These shortcuts can be used when lists appear on more than one page. However, these shortcuts do not work in the Contact Directory.

- Use the dial pad keys to navigate through and make selections in numbered menu lists.
- The navigation guide icon in the top left-hand corner of the graphic display shows which arrow keys can be used at a particular sublevel.

For example, the following figure shows that , , , and  can be used at this point.



### Note

After 20 seconds of inactivity, the menu system will also automatically exit to the idle display unless an edit session is in progress.

- To enter text using the dial pad, press the number keys one or more times. For example, for 'A' press '2' and for 'C' press '222'. The text that can be entered by a key is shown beneath the entry line. This is true for all languages that can be displayed by the phone. When in text entry mode, the title will show whether keys will generate numbers (1) or characters (a or A).

The type of text entry available is displayed in the title line.



Switch between alphabetic (with and without an uppercase letter first) and numeric text entry by pressing the # key. Special characters like \* and \_ are considered alphabetic and appear when you press \*, 1, or 0.

Switch to uppercase by pressing  and to lowercase by pressing .



**Note**

Pressing the # also allows for URL or IP address entry. These options are only available to system administrators in appropriate menu items. For example, when editing directory contacts use “Abc”, “abc”, or “123” and when editing server addresses use “URL”, “IP”, or “123”.

**Note**

To enter the “#” character, use the “\*” key to access the appropriate special character. “#” cannot be entered using its own key because it is used to change text entry modes.

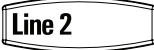
- Press and hold (for one second) from the idle display:

-  to point to the contact in the directory system where you can scroll through the individual fields.
-  to the Placed Calls list when the phone is idle.

Pressing  again will call the currently highlighted number.

Pressing  while in the dialing editor will dial the current number.

- Press and hold the **Backspace** soft key to delete an entire field.



---

# Customizing Your SoundPoint IP 32x/33x Phone

You can customize your SoundPoint IP 32x/33x desktop phone by adjusting the setting for time and date, display contrast, and ring type, for example. You can add contacts to the phone's directory manually or from call lists. You can handle incoming calls from different contacts in different ways.

This chapter provides basic operating instructions for customizing your SoundPoint IP 32x/33x phone. This chapter contains instructions on:

- [Configuring Basic Settings](#)
- [Managing Call Lists](#)
- [Managing Contacts](#)
- [Managing Incoming Calls](#)

Some customizations of your SoundPoint IP 32x/33x phone are performed by your system administrator. These include:

- [Supporting Multiple Lines](#)
- [Supporting Multiple Line Keys Per Line](#)
- [Supporting Shared Lines](#)

To read about the phone's basic features, refer to [Using the Basic Features of Your SoundPoint IP 32x/33x Phone](#) on page 3-1. To read about the phone's advanced features, refer to [Using the Advanced Features of Your SoundPoint IP 32x/33x Phone](#) on page 4-1.

If you require additional information or assistance with your new phone, contact your system administrator.

## Configuring Basic Settings

To configure basic settings, press , and then select **Settings > Basic**. You can configure the following basic settings:

- The appearance of the time and date
- Display contrast
- Backlight intensity (SoundPoint IP 335 only)
- Headset Memory Mode
- Headset hookswitch selection
- Ring type
- Language support (localization)
- Directory search

You can mute the microphone and adjust the volume using separate keys.



### Appearance of Time and Date

The time and date appears on the graphic display of the SoundPoint IP 32x/33x SIP phone. If the phone cannot obtain a time and date from a configured SNTP server, the display will flash. Contact your system administrator if either the time or date is incorrect.

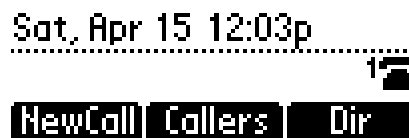
You have control over the format of the time and date display and can turn the display of time and date off. The default time and date format appears in the following figure.





**To configure the time and date:**

1. Press .
2. Select **Settings > Basic > Preferences > Time & Date**.
3. Select from **Clock Date, Clock Time, Clock Order, or Enable/Disable**.
4. Scroll through the options under each of these selections using the  and .



5. Press  to confirm your choice.  
For example, the following figure shows Clock Time.





6. Press  or  repeatedly to return to the idle display.

## Display Contrast

To adjust the contrast on the display to a comfortable level:

1. Press .
2. Select **Settings > Basic > Contrast**.
3. Press the **Up** or **Down** soft keys to increase or decrease the display contrast.



4. Press the **Save** soft key to accept changes or  to cancel changes.
5. Press  or  repeatedly to return to the idle display.

## Backlight Intensity

### Note

Backlight is available on the SoundPoint IP 335 only.

Backlight intensity has three components:

- Backlight On
- Backlight Idle
- Maximum Intensity

You can modify the Backlight On intensity and the Backlight Idle intensity separately. You can select high, medium, low, and off levels for both.

When you modify the Maximum Intensity, you are modifying the entire backlight intensity scale. For example, if you decrease the Maximum Intensity, the low, medium, and high values for both Backlight On intensity and the Backlight Idle intensity decrease.

The Backlight On intensity applies for the following events:

- Any key press
- Hookswitch release
- Incoming calls
- Ending a call, holding a call, resuming a call by the other party
- A voice or instant message received

If you do not press any keys on the phone, after 20 seconds of the backlight turning on, the backlight dims (or changes) to medium in the following cases:

- A call is in progress
- A call is on hold
- There is an incoming call (ringing)
- There is an outgoing call (ringing back)
- Any menu shows on the display

In all other cases, the Backlight Idle intensity applies.

**To modify the backlight intensity:**

1. Press  .
2. Select **Settings > Basic > Backlight Intensity**.



3. Select **Backlight On Intensity**.

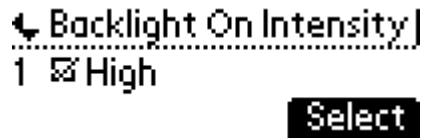

4. Use  or  to select high, medium, low, or off, and then press the **Select** soft key.

The default level is High.

5. Select **Backlight Idle Intensity**.

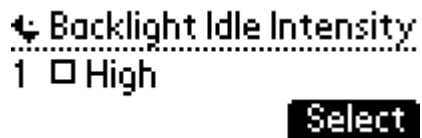

6. Use  or  to select high, medium, low, or off, and then press the **Select** soft key.

The default level is low.

7. Select **Maximum Intensity**.



8. Press the **Up** or **Down** soft keys to increase or decrease the backlight intensity.





9. Press the **Ok** or **Cancel** soft keys to accept or cancel changes.

10. Press  to return to the idle display.



## Headset Memory Mode

This feature is especially useful for permanent or full-time headset users.

### To permanently enable the Headset Memory Mode:

1. Press .
2. Select **Settings > Basic > Preferences > Headset > Headset Memory**.
3. Use the  or  to select Enabled.
4. Press  to confirm your choice.



5. Press  or  repeatedly to return to the idle display.

Repeat steps 1 to 4 to select Disabled and turn Headset Memory Mode off.

### To activate Headset Memory Mode:

- >> Press  twice.

Pressing  or **Answer** soft key to receive a call will now connect to the your headset automatically.

## Electronic Hookswitch



This feature enables electronic hookswitch support.



For information on supported headsets to provide electronic hookswitch features for placing, answering, and ending calls, go to [www.polycom.com/support/voice](http://www.polycom.com/support/voice) and enter "Headset Compatibility List" in the Knowledge Base text box or contact your system administrator.

### To select a headset that supports electronic hookswitch:

1. Press .
2. Select **Settings > Basic > Preferences > Headset > Analog Headset Mode**.

3. Use the  or  to select your headset and press the **Select** soft key.

```

Analog Headset Mode
1  Regular Mode
2  Jabra Mode





```

4. Press  or the Exit soft key repeatedly to return to the idle.

## Ring Type

You can select from the different ring types to distinguish between lines or to have a different ring from your neighbor's phone. You can set distinctive incoming ringing tones for contacts in your local directory (refer to [Editing Contacts](#) on page 1-3).

### To change the incoming ring to a desired sound:



1. Press .
2. Select **Settings > Basic > Ring Type**.
3. (Optional) If multiple lines are configured on your phone, first select the line to change from the list using  and .
4. Using  and , select the desired ring type.

Press the **Play** soft key to hear the selected ring type.

```

Ring Type
1  Silent Ring
Play Select

```

5. Press the **Select** soft key to change to the selected ring type.
6. Press  or  repeatedly to return to the idle display.

### Note

If you configure your SoundPoint IP 32x/33x phone for silent ring, press the ringing Line key or the Answer soft key to answer the call. If your handset is off hook, the call is routed to the handset. If your handset is on hook, the call is routed to the speaker.

## Language Support

Many languages are supported by the SoundPoint IP 32x/33x SIP phone.

### To change the language:

1. Press .
2. Select **Settings > Basic > Preferences > Language**.
3. Scroll through the list of available languages.



4. Press  to confirm your choice.

Text that appears on the graphic display will change to the language of your choice.

5. Press  or  repeatedly to return to the idle display.



## Directory Search

You can configure how the search of the local contact directory is performed. The local contact directory can be searched by first name or last name.

### To change the directory search parameter:

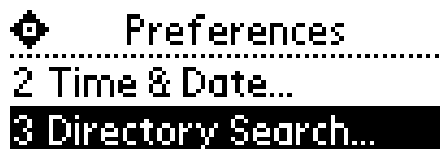
1. Press .
2. Select **Settings > Basic > Preferences > Directory search**.



3. Using  and , select the directory search parameter.  
Last name is the default directory search parameter.



4. Press  to select your choice.  
5. Press the **Yes** or **Cancel** soft keys to accept or cancel changes.

**Note**

Depending on the size of your local contact directory, the reconfiguration may take a few minutes.

The phone will restart to set the new directory search mode if you pressed the **Yes** soft key.

## Muting the Microphone

During a call, press . The Message Waiting Indicator turns red and a microphone on the screen indicates that the other party (or parties) cannot hear you.

Microphone Mute applies to all modes: Handset, Headset, and Hands-free Speakerphone. You can still hear all other parties while mute is enabled.

To turn off Microphone Mute, press  again.



## Adjusting the Volume



Press  to adjust receiver volume during a call. Pressing these keys in the idle state adjusts the ringer volume.

**Note**

To conform to regulatory requirements, handset and headset volume will return to a preset level after each call, but your system administrator can change this. Hands-free Speakerphone volume settings will be maintained across calls.

## Managing Call Lists

A list of up to four current calls is maintained. You can scroll through this list using the  and . Calls are ordered using the following priorities: active, alerting, then held. Calls with the same priorities are ordered oldest first. If there are no current calls, this list is empty.

Local lists of incoming – both missed and received calls – and outgoing (also known as placed) calls is maintained by the phone (up to 99 for each list). The initial view of both lists shows the list title and the first two calls in the list, where the first call is displayed in reverse video to indicate that it is currently selected. A symbol to indicate whether the call was answered  or missed  is shown for each entry in the incoming list.



Press the **Callers** soft key to view the Received Calls list (shown in the following figure).



Press  to view the Placed Calls list (shown in the following figure).



### To manage the listed calls:

- To return the call:
  - Press  to return the call.
- To return to the previous menu:
  - Press .
- To store the contact to the local contact directory:
  - Press  to select the entry, then press the **Save** soft key.

### Note

Press the **Info** soft key to see the call information. The name is displayed. Access the other information by using the **Up** and **Down** arrow keys.



- To delete the call from list:
  - Press the **Delete** soft key.

Press  repeatedly to return to the idle display.

#### Note

Press the Right arrow key from the idle display to access the Placed Calls list. Press the Down arrow key from the idle display to access the Received Calls list. You can use these shortcuts while placing calls or performing transferring and conferencing functions.

#### Note

You can manually clear the call lists. They are automatically cleared when you restart the phone.

## Managing Contacts

You can enter 99 contacts in your phone's local contact directory.

You can dial or search for a contact in this directory. You may be able to add, edit, and delete contacts.

You may have access to portions of your corporate directory through your phone. The contacts that you can see are determined by your system administrator. You can place calls to contacts in your corporate directory. You may be able to add contacts from the corporate directory to your local contact directory.

## Adding Contacts

You can add a contact manually or from a call list or from your corporate directory.

### Adding Contacts Manually

New entries to the local contact directory are added to the top of the list.

#### To add a contact to the local contact directory manually:

1. Press the **Dir** soft key.
2. Select the local contact directory if it does not appear automatically by pressing .

3. Press .

The Directory screen displays. <New Entry> displays at the top of the list.



**Note**

When adding the first contact, you do not need to press the **Up** arrow key.

4. Press  to add a new entry.

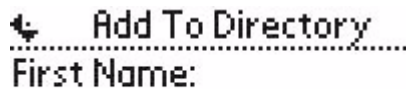

5. Press  to enter a first name.

Entry to this field is alphabetic as denoted by **Abc**.

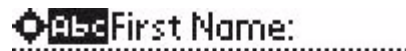

6. Enter the first name of the contact from the dial pad.



7. Press the **Ok** or **Cancel** soft keys to accept or cancel changes.

8. Press  to display the next field in the contact's entry.





9. Repeat steps 4 to 8 to enter the last name of the contact.

10. Repeat steps 4 to 8 to enter a contact number.

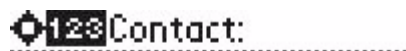
This is a required field and it must be unique (not already in the directory).

Entry to this field is number as denoted by **123**.



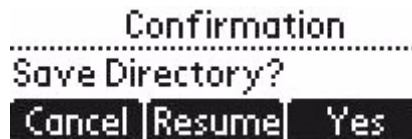

11. Repeat steps 4 to 8 to change the Speed Dial Index if desired.  
It is automatically assigned to the next available index value.  
For more information, refer to [Assigning Speed Dial Indexes](#) on page 3-14.
12. Repeat steps 4 to 8 to change the Ring Type and Divert Contact if desired.  
These fields may be left blank.  
For more information on setting the Ring Type field, refer to [Distinguishing Calls](#) on page 2-19.  
For more information on diverting contacts, refer to [Diverting Calls](#) on page 2-21.
13. Repeat steps 4 to 8 to change the Auto Reject, Auto Divert, Watch Buddy, and Block Buddy if desired.  
Use , , , or  to switch between Enabled and Disabled settings.  
For more information on setting the Auto Reject field, refer to [Rejecting Calls](#) on page 2-20.
14. Press  to end contact's data entry.



15. Press the **Yes** or **Cancel** soft keys to accept or cancel changes.
16. Press  repeatedly to return to the idle display.

### Adding Contacts From Call Lists

#### To add a contact to the local contact directory from a call list:

1. Do one of the following steps:
  - a Press the **Callers** soft key to view the Received Calls list.
  - b Press  to view the Placed Calls list.
2. Use  and  to scroll through the list to find the contact.

3. Press  to select the entry.



```

Placed Calls
-----
17 Bob Smith(5551234)
Delete Info Save
    
```

4. (Optional) Press the **Info** soft key.  
The name is displayed. The number, time and date when the call started, and call duration are accessible through use of .

```

Name:
-----
Bob Smith
Cancel
    
```



5. (Optional.) Press  repeatedly to select the phone number.
6. Press the **Save** soft key to save the contact in the local contact directory.
7. Press  repeatedly to return to the idle display.

**Note**

At this point, you may want to go to the local contact directory, check whether the contact was saved correctly, and add missing fields.

### Add Contacts From Corporate Directory

To add a contact to the local contact directory from the corporate directory:

1. Press the **Dir** soft key.
2. Press , then press  to select the corporate directory.
3. Search for the contact.  
Refer to [Searching For a Contact](#) on page 2-17.
4. Press .

The contact's information appears on the graphic display.





```

Corp Dir (Filtered)
-----
Dean, James, 61244244...
View Save Search
    
```

5. Press the **Save** soft key to save the contact in the local contact directory.  
“Entry saved” appears on the graphic display. Only the first name, last name, and phone number are saved.  
If the contact already exists in the contact directory, “Entry already exists” appears.
6. Press  repeatedly to return to the idle display.

## Editing Contacts

### To edit a contact in the local contact directory:

1. Press the **Dir** soft key.
2. Select the local contact directory if it does not appear automatically by pressing .
3. Use  and  to scroll through the list to find the contact.
4. Press  to select the entry.

```

┌ Directory
├-----
16 James Dean(612446...
└ Edit New Delete



```

5. Press the **Edit** soft key.

```

┌ Edit Contact
├-----
First Name:
└ James

```

6. Use  and  to scroll through the fields, then press  to select the field.



```

┌ First Name:
├-----
└ James
└ Cancel <<

```

7. Make the desired changes.

The **Ok** soft key is not displayed until a change has been made. The **Cancel** soft key in this context will cancel the edit session for the entry and return to the screen before the **Edit** soft key was selected (see step 3).

Press  and  to place the cursor either at the beginning or end of the item respectively. Press  to move to the next field.



8. Press the **Ok** or **Cancel** soft keys to accept or cancel changes.





9. Press  repeatedly to return to the idle display.

**Note**

You can also edit a contact associated with a speed dial key by pressing and holding that speed dial key and then following the steps 5 to 7 above.

## Deleting Contacts

**To delete a contact from the local contact directory:**

1. Press the **Dir** soft key.
2. Select the local contact directory if it does not appear automatically by pressing .
3. Use  and  to scroll through the list to find the contact.
4. Press  to select the entry.



5. Press the **Delete** soft key.





The contact is deleted from the directory. The next entry in the directory appears.

6. Press  repeatedly to return to the idle display.

## Placing a Call to a Contact

### Placing Calls From the Contact Directory

**To place a call to a contact in the local contact directory:**

1. Press the **Dir** soft key.
2. Select the local contact directory if it does not appear automatically by pressing .
3. Use  and  to scroll through the list to find the contact.
4. Press  or lift the handset.

### Placing Calls From the Corporate Directory

**To place a call to a contact in the corporate directory:**

1. Press the **Dir** soft key.
2. Select **Corporate Directory**.
3. Search for the contact.  
Refer to [Searching the Corporate Directory](#) on page 2-18.
4. Press  or lift the handset.

## Searching For a Contact

### Searching the Contact Directory

**To search for a particular contact in the local contact directory:**

1. Press the **Dir** soft key.
2. Select the local contact directory if it does not appear automatically by pressing .

**3.** Search for a contact using the dial pad.

You can change the directory search parameter used. By default, it is the contact's last name. For more information, refer to [Directory Search](#) on page 2-8.

The first time a dial pad key is pressed, the first entry whose last name starts with a character that matches the first letter on the key label will be retrieved. The second key press repeats the process using the second letter on the key and so on.

For example, to find the first directory entry whose last name starts with J, press the 5 key once. To find the first entry whose last name starts with R, press the 7 key three times.

### Searching the Corporate Directory

**To search for a particular contact in the corporate directory:**

1. Press the **Dir** soft key.
2. Select the local contact directory if it does not appear automatically by pressing .

**Note**

You can enable your phone to save Corporate Directory search results, and to remember the last person you viewed in the directory. Whenever you redisplay Corporate Directory, the last person you viewed will display. If you searched for a person, the results of the last search you submitted will display. To enable this feature, press the **Menu** key, and then select **Settings > Basic > Preferences > Corporate Directory > View Persistency**. Select **Enabled**, press the **Select** soft key, and then press the **Menu** key to exit the menu.

**3.** Search for the contact in one of the following ways:

- In the search line, enter the first few characters of the contacts' last name using the dial pad. For example, to search for James Woller, enter **wo** in the search line.
- Press the **Submit** soft key. In this example, James Woller appears in the search results..



```
Search:wo
Woller, James, 0445
Wong, Bob, 6044
```



- Press the **AdvFind** soft key, enter search values in the displayed fields. For example, enter **Smith** as the last name.



- Press the **Submit** soft key. In this example, Bob Smith appears in the search results..



You can dial any successful matches from the resulting information on the graphic display.





## Managing Incoming Calls

You can distinguish incoming calls from contacts in your directory by setting up distinctive rings, sending them directly to your voice mail, or by transferring them directly to another party.



### Distinguishing Calls

You can customize your phone so that you can distinguish different parties by ring type.

#### To set a distinctive ring type for a particular contact:

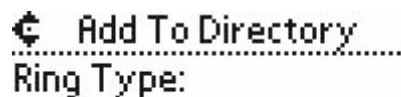
1. Press the **Dir** soft key.
2. Use  and  to scroll through the list to find the contact.
3. Press  to select the entry.
4. Press the **Edit** soft key.
5. Press  repeatedly until the Ring Type field is displayed.



6. Press  to edit the Ring Type.
7. Enter the number corresponding to one of the ring types available.  
For more information, refer to [Ring Type](#) on page 2-5.
8. (Optional) To remove an existing value, press .
9. Press the **Ok** or **Cancel** soft keys to accept or cancel changes.
10. Press  repeatedly to return to the idle display.

**Note**

This feature is local to the phone, and may be over-ridden by your organization's settings. For more information, contact your system administrator.





## Rejecting Calls

You can customize your phone so that incoming calls from a particular party are immediately sent to your voice mail.

**Note**



Rejecting calls is not available on shared lines.

**To send incoming calls from a particular contact directly to voice mail:**

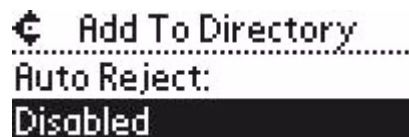
1. Press the **Dir** soft key.
2. Use  and  to scroll through the list to find the contact.
3. Press  to select the entry.
4. Press the **Edit** soft key.
5. Press  repeatedly until the Auto Reject field is displayed.







The screenshot shows a phone's display with the text "Add To Directory" at the top, followed by a dotted line separator. Below the separator, the text "Auto Reject:" is displayed, and the word "Disabled" is shown in a black box below it.

6. Press , and then  to change between Disabled and Enabled.
7. Press the **Ok** or **Cancel** soft keys to accept or cancel changes.
8. Press  repeatedly to return to the idle display.

## Diverting Calls

You can customize your phone so that incoming calls from a particular party are transferred directly to a third party.



### To divert incoming calls from a particular contact:

1. Press the **Dir** soft key.
2. Use  and  to scroll through the list to find the contact.
3. Press  to select the entry.
4. Press the **Edit** soft key.
5. Press  repeatedly until the Divert Contact field is displayed.

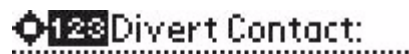

6. Press .



7. Enter the number of the party to whom you want to divert the call.
8. Press the **Ok** or **Cancel** soft keys to accept or cancel changes.
9. Scroll down to the Auto Divert field.
10. Press , and then  to change between Disabled and Enabled.
11. Press the **Ok** or **Cancel** soft keys to accept or cancel changes.
12. Press  repeatedly to return to the idle display.

### Note

Dual-tone multi-frequency (DTMF) signaling is not available while a call is incoming. You may resume DTMF signaling by pressing the **Reject** soft key (for private lines) or the **Ignore** soft key (for private and shared lines). For more information, contact your system administrator.

## System Customizations

The following section details customizations of your SoundPoint IP 32x/33x phone that are performed by your system administrator.

### Supporting Multiple Lines

Your SoundPoint IP 32x/33x phone can support up to 2 lines.

Typically, the top-most Line Key is reserved for the principal directory number (DN) of the phone.

Depending on how your phone is configured, the display could resemble one of the following figures:

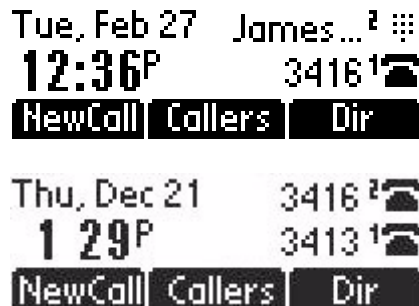

### Supporting Multiple Line Keys Per Line

Each line on the phone can be configured to have more than one Line Key associated with it. This enhances call visualization and simplifies call handling. If this is the case, the display could resemble the following figure:



Incoming calls to this line will be distributed evenly among the available Line Keys. Similarly, outgoing calls will be distributed.

The SoundPoint IP 32x/33x combines the call appearances for multiple line keys into a single call list.

The line key that a call belongs to is indicated by the reverse colored icon.

## Supporting Shared Lines

Your SoundPoint IP 32x/33x phone supports shared lines. A shared line is indicated by a different line icon. In the following figure, the line 3413 is private and the line 3416 is shared.



If two phones share a line, an incoming call to that number will cause both phones to ring. The call can be answered on either phone but not both.

Calls on shared lines can be transferred, placed on hold, or added to a conference.

**Note**

Shared lines are an optional feature and may not be supported on your particular system. For more information, contact your system administrator.

**Note**

Call Forwarding is not available on shared lines.

Do Not Disturb (DND) on shared lines disables the ringing option only, the visual indication is still in place.





---

# Using the Basic Features of Your SoundPoint IP 32x/33x Phone

Your SoundPoint IP 32x/33x phone is designed to be used like a regular phone on a public switched telephone network (PSTN). You can place calls, transfer a call to someone else, or conduct a conference call.

At any time, only one active call may be in progress on your phone. The active call is the one that has audio associated with it. There may be up to three other calls on hold or in an “Incoming call” or “Ringing” state on a particular line.

Use  and  to switch between these calls. With two lines, there can be maximum of eight calls or four conferences on your phone.

This chapter provides basic operating instructions for the SoundPoint IP 32x/33x phone. This chapter contains instructions on:



- [Placing a Call](#)
- [Answering a Call](#)
- [Ending a Call](#)
- [Redialing](#)
- [Placing a Call on Hold](#)
- [Setting Up Conferences](#)
- [Transferring Calls](#)
- [Forwarding Calls](#)
- [Enabling Do Not Disturb](#)
- [Assigning Speed Dial Indexes](#)
- [Using Voice Mail](#)

To customize your phone, refer to [Customizing Your SoundPoint IP 32x/33x Phone](#) on page 2-1. To read about the phone's advanced features, refer to [Using the Advanced Features of Your SoundPoint IP 32x/33x Phone](#) on page 4-1. Review useful tips about the phone in [Before You Use Your SoundPoint IP 32x/33x Phone](#) on page 1-12.

If you require additional information or assistance with your new phone, contact your system administrator.

## Placing a Call

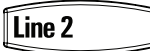

You can place a call in many ways using your SoundPoint IP 32x/33x phone:

- Using the handset
- Using the speakerphone
- Using the headset
- Using 
- Using  or 

You can also dial the number first, and then choose the method you will use to speak to the other party.

To call a speed dial number, use the dial pad to enter the speed dial index followed by the # key, and then press  or pick up the handset to place a call.

You can search the local contact directory or the corporate directory and dial from the search results page.

During a call, you can alternate between Handset, Headset, or Hands-Free Speakerphone modes by pressing the  or  keys, or picking up the handset.

Call duration on an active call is monitored through a local call timer. This is visible within the active call window on the graphic display. In the figure below, the call to James Dean has lasted 2 hours 48 minutes 23 seconds so far.





**To place a call using the handset:**

1. Do the following steps in any order:
  - Pick up the handset.

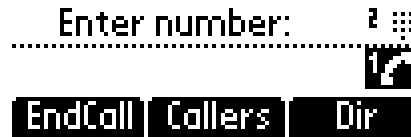

- Dial the desired number using the dial pad.

**Note**

URL or IP dialing is not supported on registered phones. If your phone is intentionally unregistered, the default dialing mode is by URL.

**To place a call using Hands-Free Speakerphone mode:****Note**

If “Handsfree mode disabled” appears on the graphic display after you press the speakerphone key, your system administrator has disabled the speakerphone on your phone.

1. Do one of the following steps:

- a With the handset on-hook, press , , , or the **NewCall** soft key to obtain dial tone.

Dial the desired number using the dial pad.

- b With the handset on-hook, dial the desired number using the dial pad.

Press , , or .

**To place a call using the headset:**

1. Do one of the following steps:

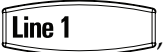
- a With the optional headset connected, press , , or the **NewCall** soft key to obtain dial tone.

Press .

Dial the desired number using the dial pad.

- b** With the optional headset connected, dial the desired number using the dial pad.

Press .





- c** Press .

You will hear a dial tone. You can enter the desired number now.

**Note**

To permanently enable your headset, refer to [Headset Memory Mode](#) on page 2-6.

**To place a call using the Dial key:**

1. Do one of the following steps:
  - a** Press the **Callers** soft key to view the Receive Call list.
  - b** Press  to view the Placed Call list.
2. Use  and  to scroll through the list to find the contact.
3. Press  to complete the call.

## Answering a Call

When you are not in another call, you can answer a call in three basic ways using your SoundPoint IP 32x/33x phone:

- Using the handset
- Using the speakerphone
- Using the headset

The steps for answering an incoming call when you are in another call are different if your phone is configured for:

- A single Line Key per line

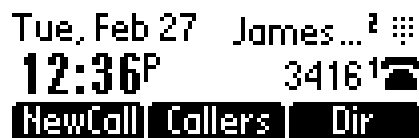

Tue, Feb 27 James...  
12:36P 34161  
NewCall Callers Dir

- Multiple Line Keys per line



If your phone is configured with multiple call appearances, refer to [Using Multiple Call Appearances](#) on page 4-3 for instructions on how to answer a call.

#### Note

Incoming calls may be ignored by pressing the **Reject** soft key (for private lines) or the **Ignore** soft key (for private and shared lines).

When your SoundPoint IP 32x/33x phone is configured for silent ring, press the ringing Line key or the **Answer** soft key to answer the call. If your handset is off hook, the call is routed to the handset. If your handset is on hook, the call is routed to the speaker.

#### Note

Dual-tone multi-frequency (DTMF) signaling is not available while a call is incoming. You may resume DTMF signaling by pressing the **Reject** soft key (for private lines) or the **Ignore** soft key (for private and shared lines). For more information, contact your system administrator.

### Answering When Not in Another Call

In all cases, the active call will appear on the graphic display showing call duration and destination.

#### To answer a call using the handset:

- Pick up the handset.

#### To answer a call using Hands-Free Speakerphone mode:

#### Note

If "Handsfree mode disabled" appears on the graphic display after you press the speakerphone key, your system administrator has disabled the speakerphone on your phone.

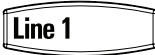
- Do one of the following steps:
  - Press .
  - With the handset on-hook, press  opposite the incoming call (where the line status indicator is flashing green).
  - Press the **Answer** soft key.

### To answer a call using the headset:

- Press  to answer the call through an optionally connected headset.

If Headset Memory Mode is activated, press  or the **Answer** soft key.

### Answering When in Another Call

You are busy on an active call and a second incoming call arrives on the same phone number.

- If your phone is configured for a single Line Key per line:
  - The second call may cause a call waiting tone to be played and you see the second call appearance. The call waiting prompt identifying the incoming caller appears for 10 seconds only. You can ignore, answer, or reject the call. (The **Reject** soft key on private lines only.)
  - After this point the active call is in focus and the user must scroll to the incoming call appearance to Answer
- If your phone is configured for multiple Line Keys per line:
  - The second call will cause a call waiting tone to be played, the second Line Key indicator to fast flash green, and an incoming call icon appears. The call waiting prompt identifying the incoming caller appears for 10 seconds only. You can ignore, answer, or reject the call. (The **Reject** soft key on private lines only.)
- If your phone is configured for shared lines:
  - The second call will cause a call waiting tone to be played, the second Line Key indicator to fast flash green, and an incoming call icon appears on the second Line Key. The call waiting prompt identifying the incoming caller appears for 10 seconds only.

#### Note

Pressing the **Ignore** soft key will stop the ringing for that call.

### To answer an incoming call on a line configured for a single Line Key:

#### Note

Use this procedure after the call prompt disappears. The call waiting prompt *interrupts* the active call for 10 seconds, where the incoming call can be immediately dealt with.

1. Press  to place the original call on hold.

2. Press  to access the new call.

Soft key labels are updated on the display showing **Ignore**, **Answer**, and **Reject**.

3. Answer the incoming call.

This places the original call on hold and refreshes the soft key labels.

### To answer an incoming call on a line configured for multiple Line Keys:

#### Note

Use this procedure after the call prompt disappears. The call waiting prompt *interrupts* the active call for 10 seconds, where the incoming call can be immediately dealt with.

- Do one of the following steps:

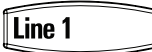
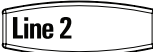
- Answer the call by pressing  or  associated with the second incoming call.

The first call is put on hold and the second call is answered.

- Press  to put the original call on hold.

Soft key labels are updated on the display showing **Ignore**, **Answer**, and **Reject**.

Answer the incoming call.



This places the original call on hold and refreshes the soft key labels.

Answering a call on shared line is no different than on private line, except that there is no **Reject** soft key and another person on the shared line might answer the call.

## Ending a Call

### To end a call:

- Do one of the following steps:

- Press the **EndCall** soft key.
- Replace the handset.
- Press  if in Hands-free Speakerphone Mode, or  if in Headset Mode.

## Redialing





**To redial any call placed from your phone:**

- Refer to [Placing a Call](#) on page 3-2.

## Placing a Call on Hold

During a call, press . This will be indicated on the graphic display by the hold icon as the line indicator.



Press  again or the **Resume** soft key to resume the call. The active audio icon (one of , , or ) appears as the line indicator.

When a call has been on hold for an extended period of time, both visual and audible alerts appear. Contact your system administrator to determine if this feature is enabled/disabled, what the time period is, and what sound effects are available. When active on a call, the sound effects are played at a volume that is typically lower than the normal ringer volume.

### Note

As using the Hold feature typically generates music or a beeping tone, avoid putting a conference call on hold.

### Multiple Calls on Hold

If multiple calls are on hold, use  and  to switch between the calls, then press the **Resume** soft key to retrieve the desired call.

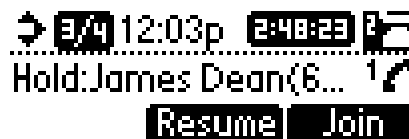

If two or more calls are on hold, an indication appears on the graphic display, for example "3/4", indicating that this is the third call out of four calls.

If calls are on hold on more than one Line Key, all calls are combined into a single call list. The Line Key that a call is associated with is indicated by the line icon in reverse colors. Pressing a Line Key with calls on hold will place the current active call on hold and resume the first call on that Line Key.

## Setting Up Conferences

You can create a conference with other parties using the phone's local conference feature.

### To set up a conference:

1. Call the first party.



### Note

You can either dial the phone number directly or search for the number in the Contact Directory or Call Lists. For more information, refer to [Placing a Call](#) on page 3-2, [Searching For a Contact](#) on page 2-17, or [Managing Call Lists](#) on page 2-10.

2. Press **Conf** soft key to create a new call.

The active call is placed on hold.





3. Call the second party.
4. When the second party answers, press the **Conf** soft key again to join all parties in the conference.



### To split a conference call:

- Press the **Split** soft key to split the conference.  
Both parties will be on hold.

**To set up a conference call using the Join soft key:**

- When you are in an active call:
  - a** If you have one call on hold (on the same line or other line), use  to go to the call on hold, then press the **Join** soft key.  
A conference is created with the active call, the call on hold and yourself.
  - b** If you have more than one call on hold, use  and  to switch to the desired call on hold, press the **Join** soft key.  
A conference is created with active call, the call on hold and yourself.

**To end a conference call:**

- Press the **EndCall** soft key or hang up.  
The other parties will continue to be connected.

## Transferring Calls

A call can be transferred in one of three ways:

- Consultative transfer – The party to whom you want to transfer the call answers their phone before you transfer the call or hang up. You can consult with them before completing the transfer.
  - [To transfer a call](#): on page 3-12.
- Blind transfer – The call is automatically transferred after you dial the number of the party to whom you want to transfer the call.
  - [To perform a blind transfer](#): on page 3-12.
- Attended transfer – The parties are automatically connected to each other after you exit the conference.
  - Set up a conference call and then end your participation. For more information, refer to [Setting Up Conferences](#) on page 3-10.



**To transfer a call:**

1. During a call, press **Trans** soft key.

The active call is placed on hold.



2. Do one of the following steps:
  - a Enter the number to which you want to transfer the call. A normal (or consultative) transfer is assumed.
  - b Press the **Normal** soft key to access the local contact directory, corporate directory, or received callers list. Then choose either the **Dir** or **Callers** soft key. Choose the number to which you want to transfer the call.
3. As soon as the ring-back sound is heard or after the party answers, press **Trans** soft key to complete the transfer.

You can talk privately to the party to which you are transferring the call before the transfer is completed.





If you are using a handset, the transfer can be completed by putting the handset on the cradle.



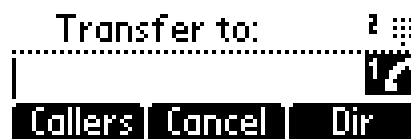



You can cancel the transfer before the call connects by pressing the **Cancel** soft key.

**To perform a blind transfer:**

1. During a call, press the **Trans** soft key.
2. Press the **Blind** soft key.



3. Do one of the following steps:
  - a Enter the number to which you want to transfer the call.
  - b Press the **Dir** soft key to access the local contact directory, use  and  to access the contacts, and then press .
  - c Press the **Dir** soft key to access the corporate directory, search for the desired contact, and then press .

- d Press the **Callers** soft key to access the Received Call list, use  and  to access the contact, and then press .
- e Press  to access the Placed Call list, use  and  to access the contact, and then press .

At this point, the call is connected to the number to which you are transferring them.

## Forwarding Calls

You can configure your phone so that all incoming calls are forwarded to another party (known as static forwarding).

All incoming calls can be forwarded to another party while Do Not Disturb is enabled on your phone. For more information, contact your system administrator.

### Note



Call Forwarding is not available on shared lines. This feature is local to the phone, and may be overridden by call server settings. For more information, contact your system administrator.



### Static Forwarding

To enable call forwarding to another party:

1. Press  and select **Features > Forward**.



2. (Optional) If multiple lines are configured on your phone, select the line to forward from the list using  and .

3. Using  and , select the forwarding type you want to change and then press . The options are:
  - **Always** – For all incoming calls
  - **No Answer** – Once all options to accept calls have been taken
  - **Busy** – When you are already in a call
4. Depending on your selection:
  - a If you select **Always**, enter a number to forward all future incoming calls to.
  - b If you select **No Answer**, enter a number to forward all unanswered incoming calls to and how many rings to wait before forwarding (one ring is approximately six seconds). A value of 2 is recommended.
  - c If you select **Busy**, enter a number to forward all future incoming calls to when you are already in another call.

**Note**

You can also enter the SIP URL or IP address. For more information on using a SIP URL or IP address, refer to [Placing a Call](#) on page 3-2

5. Select the **Enable** soft key to confirm call forwarding.



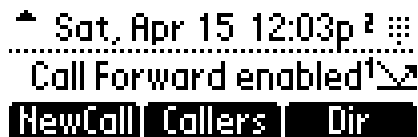

Select the **Exit** soft key to cancel any changes.

The idle display returns with a moving arrow as the line label to confirm call forwarding is enabled.



The image shows a phone's idle display. At the top, it displays the date and time: "Sat, Apr 15 12:03p". Below this, it shows "Call Forward enabled" with a small icon of a telephone handset. At the bottom, there are three soft keys: "NewCall", "Callers", and "Dir".

**To disable call forwarding:**

1. Press  and select **Features > Forward**.
2. (Optional) If multiple lines are configured on your phone, select the line to forward from the list using  and .
3. Using  and , select the forwarding type you want to change and then press the **Select** soft key.
4. Press the **Disable** soft key to turn off call forwarding.

The idle display returns and the regular icon appears as the line indicator.

## Enabling Do Not Disturb

Press  and then select **Features > Do not disturb** to prevent the phone from ringing on incoming calls. A flashing icon and text on the graphic display indicates that Do Not Disturb is on.

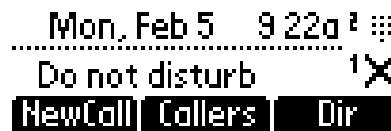



Calls received while Do Not Disturb is enabled are logged in the Missed Calls list unless configured to be forwarded to another party by your system administrator.

To disable Do Not Disturb, press  and then select **Features > Do not disturb** again.

**Note**

This feature is local to the phone, and may be overridden by call server settings. For more information, contact your system administrator.

### Multiple Lines and Do Not Disturb

If multiple lines are configured on your phone, Do Not Disturb can be set on a line-by-line basis from the list using  and . For more information, contact your system administrator. When Do Not Disturb is enabled for a particular line, this is indicated by a flashing “X” beside the line indicator on the display.

## Assigning Speed Dial Indexes

You can associate a contact with  for single touch dialing of a frequently used number.

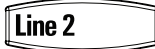
For example in the figure below, pressing  places a call to James.

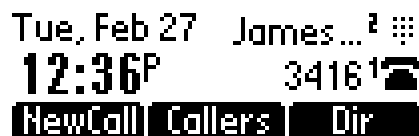

**Note**

The contact with the lowest speed dial index will be associated with the **Line 2** key for single touch dialing.

For other frequently used numbers, you can associate them with a speed dial index. To dial a contact associated with a speed dial index, enter the speed dial



index followed by the # key using the dial pad, then press  or pick up the handset

The Speed Dial list can be accessed by pressing  and selecting **Features > Speed Dial...** or by pressing the Up arrow key from the idle screen.



When a new entry is added to the Contact Directory, it is automatically assigned the next available speed dial index and the new entry appears at the bottom of the Speed Dial list.

### Assigning New Speed Dial Indexes

**To add or edit a speed dial index for an existing contact:**

1. Press the **Dir** soft key.
2. Use  and  to scroll through the list to find the contact.
3. Press  to select the entry.



4. Press the **Edit** soft key.
5. Press  repeatedly until the speed dial index appears.
6. Press  to select the speed dial index for edit.
7. Do one of the following steps:
  - Enter the next available speed dial index.
  - Delete the existing speed dial index by using the **Backspace** soft key, and then enter a new speed dial index.
8. Press the **Ok** or **Cancel** soft keys to accept or cancel changes.
9. Press  repeatedly to return to the idle display.



#### Note

Press and hold the unassigned **Line 2** key from the idle display to associate a speed dial index. The next available speed dial index will be assigned automatically.

### To assign a new speed dial key:

1. Press and hold  if unassigned.

A new empty entry in the contact directory is automatically opened allowing contact information to be added.

2. Press  to enter a first name.
3. Enter the first name of the contact from the dial pad.
4. Press the **Ok** or **Cancel** soft keys to accept or cancel changes.
5. Press  to display the next field in the contact's entry.
6. Repeat steps 2 to 5 to enter the last name of the contact.
7. Repeat steps 2 to 5 to enter a contact number.
8. Repeat steps 2 to 5 to change the Speed Dial Index if desired.

The index can be any value between the next available index value and the maximum (99).



Polycom recommends that you assign speed dial index values consecutively. For example, the second Line Key is assigned to the speed dial index value "2".

9. Press the **Yes** or **Cancel** soft keys to accept or cancel changes.
10. Press  repeatedly to return to the idle display.

#### Note

To add a speed dial contact if the **Line 2** key is already assigned, refer to [Adding Contacts](#) on page 2-11.

## Using Voice Mail

Your voice mail is saved in a centralized location and may be accessed from your phone.

The presence of new Voice Mail messages is indicated by a flashing Message Waiting Indicator LED on the front of the phone and a visual notification on the graphic display. If the phone is configured for multiple lines, an individual line indicator icon indicates Voice Mail messages left on that line.



A stutter dial tone in place of normal dial tone is used to indicate that one or more voice messages are waiting at the message center.

**Note**

Voice Mail is an optional feature configured on the call server and may not be supported on your particular system. For more information, contact your system administrator.

Screen options may vary with your application. Voice Mail may be accessible with a single key press. Contact your system administrator about this option.

**To listen to voice messages:**

1. Press the **Msgs** soft key or press , select **Features > Messages**, and then press .

**Note**

If your SoundPoint IP 32x/33x has a **Messages** key, press it to access your Voice Mail.

2. Follow voice or visual prompts on the graphic display to retrieve your messages.

If multiple lines are configured on your phone, select from which line messages are to be retrieved.





---

# Using the Advanced Features of Your SoundPoint IP 32x/33x Phone

This chapter provides operating instructions for the advanced features of the SoundPoint IP 32x/33x phone. This chapter contains instructions on:

- [SIP-B Automatic Call Distribution](#)
- [Using Multiple Call Appearances](#)
- [Using Buddy Lists](#)
- [Restarting Your Phone](#)

To customize your phone, refer to [Customizing Your SoundPoint IP 32x/33x Phone](#) on page 2-1. To read about the phone's basic features, refer to [Using the Basic Features of Your SoundPoint IP 32x/33x Phone](#) on page 3-1.

If you require additional information or assistance with your new phone, contact your system administrator.

## SIP-B Automatic Call Distribution

### Note

ACD is not available on all call servers. For more information, contact your system administrator.



Automatic call distribution (ACD) systems allow companies that handle a lot of incoming phone calls to direct them to a person who is able to talk at the earliest opportunity.

The SoundPoint IP 32x/33x phone allows:

- ACD login and logout
- ACD agent available and unavailable

When ACD is enabled on your phone, the line icon  appears. This is the default setting. No calls will be directed to your phone.

After you log in (refer to [To log into the ACD:](#)), the line icon changes to . You are now considered available and calls will be directed to your phone.

After you end a call, the line icon alternates between  and  showing you are now unavailable. You must set yourself to available for calls to be directed to you again (refer to [To set ACD agent availability:](#))

### To log into the ACD:

1. Press .
2. Select **Features > ACD Login/Logout...**



3. Select **Login**.

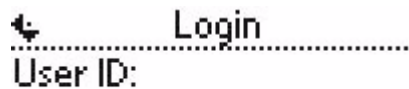

4. Press .

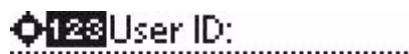

5. Enter your user ID and press the **Login** soft key.

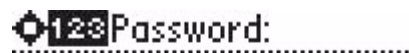

6. Press  to display the next field.

7. Press .



8. Enter your password and press the **Login** soft key.
9. Press  repeatedly to return to the idle display.





#### To log out of the ACD:

1. Press .
2. Select **Features > ACD Login/Logout...**
3. Select **Logout**.
4. Press  repeatedly to return to the idle display.

#### To set ACD agent availability:

1. Press .
2. Select **Features > ACD Agent Availabilit...**



3. Use  and  to switch between Available and Unavailable settings.
4. Press  to select the setting.
5. Press  repeatedly to return to the idle display.

Repeat steps 1 to 5 to manually set the ACD agent to unavailable.

## Using Multiple Call Appearances

Each line on the phone can be configured to have one or more call appearances. More than one call appearances is useful if there is an active call and an incoming call arrives.

For example, the first figure shows Line 2 in a held call with Dean at extension 1703 and Line 1 has a call on hold.



The second figure shows Line 1 holding a call from Bob at extension 1701.

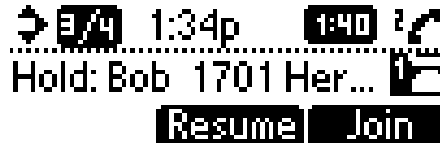

**To answer an incoming call when configured for multiple call appearances:**

➤ Do one of the following steps:

- Press **Hold** to put the original call on hold and then answer the incoming call.

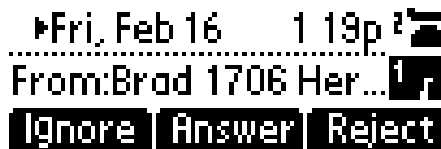

- Answer the incoming call during the Call Waiting prompt (first 10 seconds).  
Soft key labels are updated on the display with **Ignore**, **Answer**, and **Reject**.
- Wait for the Call Waiting prompt to disappear, use **Down Arrow** to scroll to the incoming call, and then answer the incoming call.

This places the original call on hold and refreshes the soft key labels.

If two or more call appearances are in use, one will appear on the display and the total number will be indicated by a counter at the top right corner of the display. For example “3/4” indicates that the highlighted call is the third one out of a total of four.

You can also place another outbound call on the same first line. Press **Hold** during the first call and press the **NewCall** soft key to obtain dial tone for a second call.

## Using Buddy Lists

Your SoundPoint IP 32x/33x phone combines interactive message services and status monitoring to complement a traditional messaging application such as e-mail.

Live interaction within a pool of phones is possible by monitoring the “presence” of the parties involved. Your phone can “watch” the status of up to 8 other phones or 8 buddies. These other phones form your “buddy list”. The status of your buddies is displayed and updated in real time. Your phone can be “watched” by up to 8 other phones.



If your SoundPoint IP 32x/33x SIP phone is configured to work with Microsoft Live Communications Server 2005, the behavior of the presence setting and buddy lists is different. For more information, contact your system administrator.

## Presence

**To view and change your presence settings:**

1. Press .
2. Select **Features > Presence > My Status**.



3. Use  or  to scroll through the list, and then press  to select your new status.

This affects information sent to phones watching you.







Presence information will also be sent to watching phones when you go off-hook or enable Do Not Disturb.

## Managing Buddies

### Note

The instructions in this section do not apply if your call server is Microsoft Live Communications Server 2005. In that case, refer to the following section, [Integrating With Microsoft Live Communications Server 2005](#).

**To add or delete a contact from your buddy list:**







1. Press the **Dir** soft key.
2. Use  or  to scroll through the list to find the contact.
3. Press  to select the entry.
4. Press  repeatedly until the Watch Buddy field appears.
5. Press  to select the Watch Buddy field.
6. Use  or  to switch between Enabled and Disabled settings.

When Watch Buddy is enabled, the contact is added to your buddy list.  
When Watch Buddy is disabled, the contact is removed from your buddy list.

The default for Watch Buddy is Disabled.

7. Press the **Ok** or **Cancel** soft keys to accept or cancel changes.
8. Press  repeatedly to return to the idle display.

**To block or unblock a contact from your buddy list:**

1. Press the **Dir** soft key.
2. Use  or  to scroll through the list to find the contact.
3. Press  to select the entry.
4. Press  repeatedly until the Block Buddy fields.
5. Press  to select the Block Buddy field.
6. Use  or  to switch between Enabled and Disabled settings.

When Block Buddy is enabled, the contact cannot watch your phone.  
When Block Buddy is disabled, the contact can watch your phone.

The default for Block Buddy is Disabled.

7. Press the **Ok** or **Cancel** soft keys to accept or cancel changes.
8. Press  repeatedly to return to the idle display.

## Integrating With Microsoft Live Communications Server 2005







Your phone can be configured to work with Microsoft Live Communications Server 2005 and communicate with others using Microsoft Office Communicator and Windows Messenger. From your phone, you can invite, join, control, and monitor integrated multipoint audio and video conferences.

Any contacts added through your buddy list will appear as a contact in Microsoft Office Communicator and Windows Messenger. Any contacts added as a contact in Microsoft Office Communicator and Windows Messenger will appear in your buddy list.

To view and change your presence, refer to [To view and change your presence settings](#): on page 4-5.



For more information, contact your system administrator.







### To add a contact to your buddy list:

1. Press .
2. Select **Features > Presence > Buddy Status**.
3. Do one of the following steps:
  - a If the buddy list is empty, press  to enter a new buddy's contact number.
  - b If the buddy list is not empty, use  to scroll up the new entry, press  to enter a new buddy's contact number.
  - c If the buddy list is not empty, press  to select an entry, then press the **Add** soft key to add a new entry.
4. Enter the desired contact number and press the **Ok** soft key.
5. Press  repeatedly to return to the idle display.

You can also delete a contact or dial a contact from your buddy list.

### To view and change your privacy list:

1. Press .
2. Select **Features > Presence > Privacy List**.
3. Use  or  to scroll through the list to find the contact.

4. Press  to select the entry.
5. Press **Edit** soft key.
6. Press  to scroll through the list to find the *Access* field.
7. Press  to select the field.
8. For *Access*, use  or  to select Enabled.  
When *Access* is enabled, you are allowing the contact to see your presence.  
When *Access* is disabled, you are disallowing the contact from seeing your presence.  
The default for access is Disabled.
9. Press  repeatedly to return to the idle display.

You can also delete a contact or dial a contact from your privacy list.

For more information on contacting buddies, refer to [Placing a Call](#) on page 3-2 or the Microsoft Office Communicator and Windows Messenger documentation.

## Restarting Your Phone

Periodically, you may need to restart your phone. The reasons for this include:

- Accepting a new configuration
- Accepting new software

**Note**

In the case of problems, it may be possible to restore normal operation of your phone without restarting. Contact your system administrator before attempting to restart your phone.

**Note**

The call lists are automatically cleared when you restart the phone.



**To restart the phone:**

1. Press  .
2. Select **Settings > Basic> Restart Phone**.  
“Are you sure?” appears on the graphic display.
3. If you still want to restart your phone, press the **Yes** soft key.  
The restart process process begins. The process ends when the idle display appears.



---

# Troubleshooting Your SoundPoint IP 32x/33x Phone

This chapter contains general troubleshooting information to help you solve any problems you might encounter when you use your SoundPoint IP 32x/33x phone. The table in this chapter list possible trouble symptoms, the likely causes of these problems, and the recommended corrective actions to take.

- [Power and Startup](#)
- [Controls](#)
- [Access to Screens and Systems](#)
- [Calling](#)
- [Displays](#)
- [Audio](#)
- [Productivity Suite](#)

To obtain more detailed troubleshooting information, you can access certain menus on your phone that test your phone hardware. For more information, see [Testing Phone Hardware](#) on page 5-8.

If you require additional assistance, contact your system administrator.

## Power and Startup

Symptom	Problem	Corrective Action
There are power issues.	The SoundPoint IP 32x/33x phone has no power.	Do one of the following steps: <ul style="list-style-type: none"><li>• Verify that no lights appear on the phone when it is powered up.</li><li>• Check if the phone is properly plugged into a functional AC outlet.</li><li>• Make sure that the phone isn't plugged into a plug controlled by a light switch that is off.</li><li>• If the phone is plugged into a power strip, try plugging it directly into a wall outlet instead.</li><li>• Try the phone in another room where the electricity is known to be working on a particular outlet.</li></ul>

## Controls

Symptom	Problem	Corrective Action
<p>The dial pad does not work.</p>	<p>The dial pad on the SoundPoint IP 32x/33x phone does not respond.</p>	<p>Do one of the following steps:</p> <ul style="list-style-type: none"> <li>• Check for a response from other feature keys or from the dial pad.</li> <li>• Place a call to the phone from a known working telephone. Check for display updates.</li> <li>• Check if the LAN port is active or inactive. Press the menu key, and then select <b>Status &gt; Network &gt; Ethernet</b>. From the Ethernet page, scroll to the LAN port field and verify that it is active.</li> <li>• Check the termination at the switch or hub end of the network LAN cable. Ensure that the switch/hub port connected to the telephone is operational (if not accessible, contact your system administrator).</li> <li>• Before restarting your phone (refer to <a href="#">Restarting Your Phone</a> on page 4-8), contact your system administrator. Your system administrator may want to troubleshoot your phone in more detail before restarting the phone and losing current status information.</li> </ul>

## Access to Screens and Systems

Symptom	Problem	Corrective Action
There is no response when you press a feature key.	The SoundPoint IP 32x/33x phone is not in an active state.	<p>Do one of the following steps:</p> <ul style="list-style-type: none"> <li>• Press the keys more slowly.</li> <li>• Check with your system administrator to see if the key has been mapped to a different function or is disabled.</li> <li>• Place a call to the phone to check that inbound call display and ringing is normal. If successful, try to press feature keys within the call to access the Menu, for example.</li> <li>• To confirm that the line is active, press the <b>Menu</b> key, and then select <b>Status &gt; Lines &gt; Line Information</b>. From the Line Information page, verify that your phone line is registered.</li> <li>• To attempt re-registration to the call server, reboot your phone. Contact your system administrator.</li> </ul>
The display shows “Network Link is Down”.	The LAN cable is not properly connected.	<p>Do one of the following steps:</p> <ul style="list-style-type: none"> <li>• Check termination at the switch or hub (furthest end of the cable from the phone).</li> <li>• Check that the switch or hub is operational (flashing link/status lights) or contact your system administrator.</li> <li>• Check if the LAN port is active or inactive. Press the menu key, and then select <b>Status &gt; Network &gt; Ethernet</b>. From the Ethernet page, scroll to the LAN port field and verify that it is active.</li> <li>• To attempt re-registration to the call server, reboot your phone. Contact your system administrator.</li> </ul>

## Calling

Symptom	Problem	Corrective Action
There is no dial tone.	Power is not correctly applied to the SoundPoint IP 32x/33x phone.	<p>Do one of the following steps:</p> <ul style="list-style-type: none"> <li>• Check that the display is illuminated.</li> <li>• Make sure the LAN cable is inserted properly at the rear of the phone (try unplugging and re-inserting the cable).</li> <li>• If using Power over Ethernet (PoE), have your system administrator check that the switch is supplying power to the phone.</li> </ul>
	Dial tone is not present on one of the audio paths.	<p>Do one of the following steps:</p> <ul style="list-style-type: none"> <li>• Switch between Handset, Headset (if present) or Hands-Free Speakerphone to see if the dial tone is present on other paths.</li> <li>• If the dial tone exists on another path, connect a different handset or headset to isolate the problem.</li> </ul>
	The phone is not registered.	Contact your system administrator.

Symptom	Problem	Corrective Action
The phone does not ring.	Ring setting or volume is low.	Do one of the following steps: <ul style="list-style-type: none"> <li>• Adjust the ringing level from the front panel using the volume up/down keys.</li> <li>• Check status of handset, headset (if connected), and Hands-Free Speakerphone.</li> </ul>
	Outbound or inbound calling is unsuccessful.	Do one of the following steps: <ul style="list-style-type: none"> <li>• Place a call to the phone under investigation. Check that the display indicates incoming call information.</li> <li>• Lift the handset. Ensure the dial tone is present and place a call to another extension or number. Check that the display changes in response.</li> </ul>
	You turned off the ringer.	Do one of the following steps: <ul style="list-style-type: none"> <li>• During an incoming call, lift the handset, press the <b>Speakerphone</b> key or press the <b>Headset</b> key to obtain a dial tone.</li> <li>• Press the ringing Line Key or the <b>Answer</b> soft key to answer the call.</li> <li>• If the handset is off-hook when you press the <b>Answer</b> soft key or the Line Key, the call is routed to the handset.</li> <li>• If the handset is on-hook when you press the <b>Answer</b> soft key or Line Key, the call is routed to the speaker.</li> </ul>
"Service Unavailable" appears on the graphic display.	The user pressed the New Call soft key, dialed a number with the handset on-hook, or attempted to make a call from the contact directory when the phone was not registered.	Check with your system administrator to see when your phone will be registered.
The line icon shows an unregistered line icon.	The phone line is unregistered.	Contact your system administrator.



## Displays

Symptom	Problem	Corrective Action
<p>There is no display. The display is incorrect. The display has bad contrast.</p>	<p>Power is not correctly applied to the SoundPoint IP 32x/33x phone.</p>	<p>Do one of the following steps:</p> <ul style="list-style-type: none"> <li>• Check that the display is illuminated.</li> <li>• Make sure the LAN cable is inserted properly at the rear of the phone (try unplugging and re-inserting the cable).</li> <li>• If using Power over Ethernet (PoE), have your system administrator check that the switch is supplying power to the phone.</li> <li>• Use the screen capture feature. Contact your system administrator to determine if it is enabled.</li> </ul>
	<p>The contrast needs adjustment.</p>	<p>Do one of the following steps:</p> <ul style="list-style-type: none"> <li>• Refer to <a href="#">Display Contrast</a> on page 2-3.</li> <li>• Reboot the phone to obtain a default level of contrast.</li> <li>• Use the screen capture feature. Contact your system administrator to determine if it is enabled.</li> </ul>
	<p>Outbound or inbound calling is unsuccessful.</p>	<p>Do one of the following steps:</p> <ul style="list-style-type: none"> <li>• Place a call to the phone under investigation. Check that the display indicates incoming call information.</li> <li>• Lift the handset. Ensure the dial tone is present and place a call to another extension or number. Check that the display changes in response.</li> </ul>
<p>The display flickers.</p>	<p>A certain type of older fluorescent lighting causes the display to appear to flicker.</p>	<p>Do one of the following steps:</p> <ul style="list-style-type: none"> <li>• Move the SoundPoint IP 32x/33x SIP phone away from the lights.</li> <li>• Replace the lights.</li> <li>• Use the screen capture feature. Contact your system administrator to determine if it is enabled.</li> </ul>

## Audio

Symptom	Problem	Corrective Action
There is no audio on the headset.	The connections are not correct.	Do one of the following steps: <ul style="list-style-type: none"> <li>Ensure the headset is plugged into the jack marked Headset at the rear of the phone.</li> <li>Ensure the headset amplifier (if present) is turned on and/or the volume is correctly adjusted. If the amplifier uses batteries, check that they are fully charged.</li> </ul>
You are using a headset and the people you call hear echo.	There may be an issue with the echo cancellation feature of your headset.	Do the following: <ul style="list-style-type: none"> <li>Press the Menu key, then select Settings &gt; Basic &gt; Preferences &gt; Headset &gt; Echo Cancellation.</li> <li>Using the arrow keys, select Enabled, and then press the Select soft key.</li> <li>Contact your system administrator.</li> </ul>

## Productivity Suite

Symptom	Problem	Corrective Action
You are trying to access one of the following features, but it is not available on your phone: <ul style="list-style-type: none"> <li>Corporate Directory</li> <li>Recording and Playback of Audio Calls</li> <li>Managing Conferences audio on the headset.</li> </ul>	The license is not installed on your phone or it has expired.	Do the following: <ul style="list-style-type: none"> <li>Press the Menu key, then select Status &gt; Licenses.</li> <li>Using the arrow keys, verify that the features that you want to use has a valid license.</li> <li>Contact your system administrator.</li> </ul>

## Testing Phone Hardware

Your system administrator may ask you to access a diagnostics menu on your phone to test your phone hardware. From the diagnostics menu, you can test your phone's microphones, speaker, handset, third-party headset (if present), keypad mappings, and LCD display. See your system administrator for instructions on how to perform these tests.

**To test your phone hardware:**

- >> Press , and then select **Status > Diagnostics > Test Hardware > Audio Diagnostics, Keypad Diagnostics, or Display Diagnostics.**



---

# Regulatory Notices

<b>Service Agreements</b>
Please contact your Polycom Authorized Reseller for information about service agreements applicable to your product.

<b>Governing Law</b>
<p>This Limited Warranty and Limitation of Liability shall be governed by the laws of the State of California, U.S.A., and by the laws of the United States, excluding their conflicts of laws principles. The United Nations Convention on Contracts for the International Sale of Goods is hereby excluded in its entirety from application to this Limited Warranty and Limitation of Liability.</p> <p>All rights reserved under International and Pan-American Copyright Conventions. No part of the contents of this manual may be copied, reproduced, or transmitted in any form or by any means, or translated into another language or format, in whole or part, without written consent from Polycom, Inc. Do not remove (or allow anybody else to remove) any product identification, copyright or other notices.</p>

<b>Limitations of Liability</b>
LIMITATION OF LIABILITY. TO THE FULL EXTENT ALLOWED BY LAW, POLYCOM EXCLUDES FOR ITSELF AND ITS SUPPLIERS ANY LIABILITY, WHETHER BASED IN CONTRACT OR TORT (INCLUDING NEGLIGENCE), FOR INCIDENTAL, CONSEQUENTIAL, INDIRECT, SPECIAL, OR PUNITIVE DAMAGES OF ANY KIND, OR FOR LOSS OF REVENUE OR PROFITS, LOSS OF BUSINESS, LOSS OF INFORMATION OR DATA, OR OTHER FINANCIAL LOSS ARISING OUT OF OR IN CONNECTION WITH THE SALE, INSTALLATION, MAINTENANCE, USE, PERFORMANCE, FAILURE, OR INTERRUPTION OF ITS PRODUCTS, EVEN IF POLYCOM OR ITS AUTHORIZED RESELLER HAS BEEN ADVISED OF THE POSSIBILITY OF SUCH DAMAGES, AND LIMITS ITS LIABILITY TO REPAIR, REPLACEMENT, OR REFUND OF THE PURCHASE PRICE PAID, AT POLYCOM'S OPTION. THIS DISCLAIMER OF LIABILITY FOR DAMAGES WILL NOT BE AFFECTED IF ANY REMEDY PROVIDED HEREIN SHALL FAIL OF ITS ESSENTIAL PURPOSE.

### **Polycom Limited Warranty and Limitation Liability**

LIMITED WARRANTY. Polycom warrants to the end user (“Customer”) that this product is expected to be free from defects in workmanship and materials, under normal use and service, for one year from the date of purchase from Polycom or its authorized reseller.

Polycom’s sole obligation under this express warranty is at Polycom’s option and expense, to repair the defective product or part, deliver to Customer an equivalent product or part to replace the defective item, or if neither of the two foregoing options are reasonably available, Polycom may, on its sole discretion, refund to Customer the purchase price paid for the defective product. All products that are replaced will become the property of Polycom. Replacement products or parts may be new or reconditioned.

Polycom is expected to warrant any replaced or repaired product or part for ninety (90) days from shipment, or the remainder of the initial warranty period, whichever is longer. Products returned to Polycom must be sent prepaid and packaged appropriately for safe shipment, and it is recommended that they be insured or sent by a method that provides for tracking of the package. Responsibility for loss or damage does not transfer to Polycom until the returned item is received by Polycom. The repaired or replaced item will be shipped to Customer, at Polycom’s expense, not later than thirty (30) days after Polycom receives the defective product, and Polycom will retain risk of loss or damage until the item is delivered to Customer.

The product software comes with 90-day software warranty, providing for software updates (minor releases/bug fixes). To continue to receive support, purchasing a maintenance contract is the most economical solution.

### **Exclusions**

Polycom will not be liable under this limited warranty if its testing and examination disclose that the alleged defect or malfunction in the product does not exist or results from:

- Failure to follow Polycom’s installation, operation, or maintenance instructions.
- Unauthorized product modification or alteration.
- Unauthorized use of common carrier communication services accessed through the product.
- Abuse, misuse, negligent acts or omissions of Customer and persons under Customer’s control; or
- Acts of third parties, acts of God, accident, fire, lightening, power surges or outages, or other hazards.

### **Warranty Exclusive**

IF A POLYCOM PRODUCT DOES NOT OPERATE AS WARRANTED ABOVE, CUSTOMER’S SOLE REMEDY FOR BREACH OF THAT WARRANTY SHALL BE REPAIR, REPLACEMENT, OR REFUND OF THE PURCHASE PRICE PAID, AT POLYCOM’S OPTION. TO THE FULL EXTENT ALLOWED BY LAW, THE FOREGOING WARRANTIES AND REMEDIES ARE EXCLUSIVE AND ARE IN LIEU OF ALL OTHER WARRANTIES, TERMS, OR CONDITIONS, EXPRESS OR IMPLIED, EITHER IN FACT OR BY OPERATION OF LAW, STATUTORY OR OTHERWISE, INCLUDING WARRANTIES, TERMS, OR CONDITIONS OF MERCHANTABILITY, FITNESS FOR A PARTICULAR PURPOSE, SATISFACTORY QUALITY, CORRESPONDENCE WITH DESCRIPTION, AND NON-INFRINGEMENT, ALL OF WHICH ARE EXPRESSLY DISCLAIMED. POLYCOM NEITHER ASSUMES NOR AUTHORIZES ANY OTHER PERSON TO ASSUME FOR IT ANY OTHER LIABILITY IN CONNECTION WITH THE SALE, INSTALLATION, MAINTENANCE OR USE OF ITS PRODUCTS.

## Safety and Compliance

### Part 15 FCC Rules

This device is compliant with Part 15 of the FCC Rules. Operation is subject to the following two conditions:

1. This device may not cause harmful interference, and
2. This device must accept any interferences received, including interference that may cause undesired operation.

### Class B Digital Device or Peripheral

Note: This equipment is tested and complies with the limits for a Class B digital device, pursuant to Part 15 of the FCC Rules. These limits are designed to provide reasonable protection against harmful interference in a residential installation. This equipment generates, uses, and can radiate radio frequency energy and, if not installed and used in accordance with the instructions, may cause harmful interference to radio communications. However, there is no guarantee that interference will not occur in a particular installation. If this equipment does cause harmful interference to radio or television reception, which can be determined by turning the equipment off and on, the user is encouraged to try to correct the interference by one or more of the following measures:

1. Reorient or relocate the receiving antenna.
2. Increase the separation between the equipment and receiver.
3. Connect the equipment into an outlet on a circuit different from that to which the receiver is connected.
4. Consult the dealer or an experience radio/TV technician for help.

### Modifications

In accordance with Part 15 of the FCC Rules, the user is cautioned that any changes or modifications not expressly approved by Polycom, Inc. could void the user's authority to operate the equipment. This equipment may not be used on a coin service or party line.

### Installation Instructions

Installation must be performed in accordance with all relevant national wiring rules.

L'Installation doit être exécutée conformément à tous les règlements nationaux applicable au filage électrique.

### Plugs Acts as Disconnect Device

The socket outlet to which this apparatus is connected must be installed near the equipment and must always be readily accessible.

La prise électrique à laquelle l'appareil est branché doit être installée près de l'équipement et doit toujours être facilement accessible.

### Industry Canada (IC)

This Class [B] digital apparatus complies with Canadian ICES-003.

Cet appareil numérique de la classe [B] est conforme à la norme NMB-003 du Canada.

### CE and VCCI Mark

This SoundPoint IP 321, 331, or 335 SIP is marked with the CE mark. This mark indicates compliance with EEC directories 89/336/EEC and 73/23/EEC. A full copy of the Declaration of Conformity can be obtained from Polycom Ltd., 270 Bath Road, Slough, Berkshire, SL1 4DX, UK.

この装置は、情報処理装置等電波障害自主規制協議会（VCCI）の基準に基づくクラスB情報技術装置です。この装置は、家庭環境で使用することを目的としていますが、この装置がラジオやテレビジョン受信機に近接して使用されると、受信障害を引き起こすことがあります。

取扱説明書に従って正しい取り扱いをして下さい。

### Safety and Compliance (continued)

#### Russian Compliance

Ministry of Information Technologies & Communication of the Russian Federation - Declaration of Conformity. DoC # Д-СПД-2950. Expiry 22.06.2012.

Ministry of Information Technologies & Communication of the Russian Federation - Declaration of Conformity. DoC # Д-СПД-2948. Expiry 22.06.2012.

Ministry of Information Technologies & Communication of the Russian Federation - Declaration of Conformity. DoC # Д-СПД-2949. Expiry 22.06.2012.

Ministry of Information Technologies & Communication of the Russian Federation - Declaration of Conformity. DoC # Д-СПД-2947. Expiry 22.06.2012.

GOST-R

Certificate # POCC US.MJ05.B00987. Expiry 21.06.2012.

#### New Zealand Telepermit

Polycom SoundPoint IP321, 331, and 335 VoIP Telephone PTC 220/08/063

PTC General Warning

The grant of a Telepermit for any item of terminal equipment indicates only that Telecom has accepted that the item complies with minimum conditions for connection to its network. It indicates no endorsement of the product by Telecom, nor does it provide any sort of warranty. Above all, it provides no assurance that any item will work correctly in all respects with another item of Telepermitted equipment of a different make or model, nor does it imply that any product is compatible with all of Telecom's network services.

The Use of IP Networks through the PSTN

Internet Protocol (IP) by its nature introduces delay into speech signals as each data packet is formulated and addressed. Telecom Access Standards recommends that suppliers, designers and installers using this technology for calls to or from the PSTN refer to ITU E Model requirements in the design of their networks. The overall aim is to minimise delay, distortion and other transmission impairments, particularly for those calls involving cellular and international networks, which already suffer extensive delay.

The Use of Voice Compression through the PSTN

Because of the extensive delay already experienced when calling cellular and international networks, some of which is already caused by their use of voice compression technologies. Telecom Access Standards will only approve G711 voice technology for use on the PSTN. G711 is an 'Instantaneous Speech encoding Technique' whereas G729 and all its variants are considered 'Near Instantaneous' introducing additional delay into the speech signal.

Echo Cancellation

Echo cancellers are not normally required in the Telecom PSTN because geographic delays are acceptable where CPE return loss is maintained within Telepermit limits. However, those private networks making use of Voice over IP technology are required to provide echo cancellation for all voice calls. The combined effect of audio / VoIP conversion delay and IP routing delay can cause the echo cancellation time of 64 mS to be required.

Modification of this Polycom SoundPoint IP321, 331, and 335 VoIP Telephone for the New Zealand Network

All samples of Polycom SoundPoint IP321, 331, and 335 VoIP Telephones connected to the Telecom network shall be equipped with the following software batch Rev 3.0.2.0917. Equipped with this software batch the IP telephone is known to comply with the New Zealand speech transmission plan.



---

# Index

## Symbols

# key, page down shortcut 1-12

\* key, page up shortcut 1-12

## Numerics

123 icon 2-12

## A

ABC icon 2-12

answering calls 3-4, 3-5

assembling your phone 1-3

assigning speed dial indexes 3-14

## B

base, attaching 1-6, 1-8

block buddies 4-6

buddy lists 4-5

## C

call lists

types of 2-10

calls

ending 3-7

on hold 3-8

with handsets 3-3

with headsets 3-3

conferences, setting up 3-9

contact directory 2-11

contact lists. *See* buddy lists

corporate directory 2-17

customizing your phone 2-1

## D

data entry 1-12

data entry, switching modes 1-12

directory search 2-8

directory, contacts 2-11

display contrast 2-3, 2-5

Do Not Disturb 3-14

## E

electronic hookswitch 2-6

ending calls 3-7

## F

features

advanced 4-1

basic 3-1

list of 1-9

SoundPoint IP 330 1-9

forwarding calls 3-12

## G

getting started 1-1

## H

handset

answering a call 3-5

connecting 1-5

illustration 1-2

placing a call 3-3

hands-free mode

answering a call 3-5

disabled 3-3

placing a call 3-3

headset

answering a call 3-6

connecting 1-5

electronic hookswitch 2-6

memory mode 2-6

placing a call 3-3

headset jack 1-5

headset memory mode 2-6

holding calls 3-8

## I

idle display 2-2

inactivity timer 1-12

## L

language support 2-8

## M

managing buddies 4-5

Microsoft Office Live Communications  
Server 2005 4-5, 4-7

multiple call appearances 4-3

multiple calls, hold 3-8

multiple keys per line 2-22

multiple lines

call forwarding 3-12

Do Not Disturb 3-14

ring type 2-7

support for 2-21

Voice Mail 3-17

muting microphone 2-9

MyStat 4-5

## N

navigation guide icon 1-12

navigation key usage 1-12

network connection, phone 1-4

## P

parts list 1-2

placing calls 3-2

PoE. *See* Power over Ethernet

Power over Ethernet (PoE) 1-4

power source, phone 1-4

presence 4-5

privacy list 4-7

## R

redialing numbers 3-8

restarting phones 4-8

ring types 2-7

RJ-9 1-5

## S

shared lines 2-22

shortcuts 1-12

silent ring, answering calls 3-5

SoundPoint IP 320, 321, 331, 335. *See* SoundPoint  
IP 32x/33x

SoundPoint IP 32x/33x

adjusting display constrast 2-3, 2-5

adjusting volume 2-9

advanced features 4-1

answering calls 3-4, 3-5

assembling 1-3

assigning speed dial indexes 3-14

attaching base 1-6, 1-8

basic features 3-1

buddy lists 4-5

call lists, types of 2-10

calls, on hold 3-8

contact directory 2-11

customizing 2-1

data entry 1-12

Do Not Disturb 3-14

electronic hookswitch 2-6

ending calls 3-7

features, list of 1-9

figure, features 1-9

forwarding calls 3-12

getting started 1-1

handset 1-5

headset 1-5

headset memory mode 2-6

idle display 2-2

illustration 1-2

language support 2-8

multiple call appearances 4-3

multiple keys per line 2-22

muting microphone 2-9

navigation key usage 1-12

parts list 1-2

placing calls 3-2

presence 4-5

redialing numbers 3-8

restarting phone 4-8

ring type 2-7

setting time and date 2-2

setting up conferences 3-9

shared lines 2-22

shortcuts 1-12

text entry 1-12

transferring calls 3-10

troubleshooting 5-1

using multiple lines 2-21

voice mail 3-16

speakerphone. *See* hands-free mode

speed dialing 3-14

switching entry modes 1-12

system administrators, text entry 1-13

**T**

text entry 1-12

time and date 2-2

transferring calls 3-10

troubleshooting

- audio problems 5-8

- calling problems 5-5

- controls problems 5-3

- diagnostics 5-8

- display problems 5-7

- power and startup problems 5-2

- screen and system problems 5-4

**U**

useful tips 1-12

**V**

voice mail 3-16

volume 2-9

**W**

watch buddies 4-6



# End-User License Agreement for Polycom® Software

This End-User License Agreement (“Agreement”) is a legal agreement between you (either an individual or a single entity) and Polycom, B.V for the Polycom Software Product licensed by Polycom B.V in Europe, the Middle East, Africa, and Asia Pacific or Polycom, Inc., for the Polycom Software Product licensed by Polycom, Inc. in the rest of the world (collectively, “Polycom”). The Software Product includes the computer software included herewith and may include associated media, printed materials and online or electronic documentation (“Software Product”). By clicking ‘I agree’ or by installing, copying, or otherwise using the Software Product, you agree to be bound by the terms of this Agreement. If you do not agree to the terms of this Agreement, do not install or use the Software Product, and return it to your place of purchase for a full refund.

The Software Product is protected by copyright laws and international copyright treaties, as well as other intellectual property laws and treaties. The Software Product is licensed (not sold) to you, and its use is subject to the terms of this Agreement.

## 1. GRANT OF LICENSE.

Subject to the terms of this Agreement, Polycom grants to you a nonexclusive license to install and use the Software Product included with the Polycom product that incorporates or uses the Software Product (the “Product”). You may use the Software Product only in connection with the use of the Product. You are not permitted to lease, rent, distribute or sublicense the Software Product or to use the Software Product in a time-sharing arrangement or in any other unauthorized manner. Further, no license is granted to you in the human readable code of the Software Product (source code). Except as provided below, this License Agreement does not grant you any rights to patents, copyrights, trade secrets, trademarks, or any other rights in respect to the Software Product.

## 2. DESCRIPTION OF OTHER RIGHTS AND LIMITATIONS.

**2.1 Limitations on Reverse Engineering, Decompilation, and Disassembly.** You may not reverse engineer, decompile, or disassemble the Software Product, except and only to the extent that such activity is expressly permitted by applicable law notwithstanding this limitation. The Software Product is licensed as a single product. Its component parts may not be separated for use on more than one Product.

**2.2 Backup.** Except as expressly provided for under this Agreement, you may not copy the Software Product, except, however, you may keep one copy of the Software Product and, if applicable, one copy of any previous version for back-up purposes, only to be used in the event of failure of the original. All copies of the Software Product must be marked with the proprietary notices provided on the original Software Product. You may not reproduce the supporting documentation accompanying the Software Product.

**2.3 Modifications.** You may not modify, translate, or create derivative works of the Software Product.

**2.4 Proprietary Notices.** You may not remove or obscure any proprietary notices on or in the Software Product or the supporting documentation.

**2.5 Software Transfer.** You may permanently transfer all of your rights under this Agreement provided you retain no copies, you transfer all of the Software Product (including all component parts, the media, any printed materials, any upgrades, this Agreement, and, if applicable, the Certificate of Authenticity), and any recipient agrees to the terms of this Agreement. If the Software Product is an upgrade, any transfer must include all prior versions of the Software Product. However, if the Software Product is marked “Not for Resale” or “NFR,” you may not resell it or otherwise transfer it for value.

**2.6 Copyright.** All title and copyrights in and to the Software Product (including, but not limited to, any images, photographs, animations, video, audio, music, text, and “applets” incorporated into the Software Product), the accompanying printed materials, and any copies of the Software Product are owned by Polycom or its suppliers. The Software Product is protected by copyright laws and international treaty provisions. Title, ownership rights, and intellectual property rights in the Software Product shall remain In Polycom or its suppliers. Title and related rights in the content accessed through the Software Product is the property of such content owner and may be protected by applicable law. This Agreement gives you no rights in such content.

**2.7 Confidentiality.** The Software Product contains valuable proprietary information and trade secrets of Polycom and its suppliers and you shall protect the confidentiality of, and avoid disclosure and unauthorized use of, the Software Product.

**2.8 Dual-Media Software.** You may receive the Software Product in more than one medium. Regardless of the type or size of medium you receive, you may use only one medium that is appropriate for your single Product. You may not use or install the other medium on another Product.

**2.9 Reservation.** Polycom reserves all rights in the Software Product not expressly granted to you in this Agreement.

### **3. SUPPORT SERVICES.**

Polycom may provide you with support services related to the Software Product (“Support Services”). Use of Support Services is governed by the Polycom policies and programs described in the Polycom-provided materials. Any supplemental software code provided to you as part of the Support Services is considered part of the Software Product and is subject to the terms and conditions of this Agreement. With respect to technical information you provide to Polycom as part of the Support Services, Polycom may use such information for its business purposes, including for product support and development. Polycom will not utilize such technical information in a form that personally identifies you.

### **4. TERMINATION.**

Without prejudice to any other rights, Polycom may terminate this Agreement if you fail to comply with any of the terms and conditions of this Agreement. In such event, you must destroy all copies of the Software Product and all of its component parts. You may terminate this Agreement at any time by destroying the Software Product and all of its component parts.

### **5. UPGRADES.**

If the Software Product is labeled as an upgrade, you must be properly licensed to use the software identified by Polycom as being eligible for the upgrade in order to use the Software Product. A Software Product labeled as an upgrade replaces and/or supplements the software that formed the basis for your eligibility for the upgrade. You may use the resulting upgraded Software Product only in accordance with the terms of this Agreement. If the Software Product is an upgrade of a component of package of software programs that you licensed as a single product, the Software Product may be used and transferred only as part of that single Software Product package and may not be separated for use on more than one Product.

### **6. WARRANTY AND WARRANTY EXCLUSIONS.**

**6.1 Limited Warranty.** Polycom warrants that (a) the Software Product will perform substantially in accordance with the accompanying documentation for a period of ninety (90) from the date of receipt by you, and (b) any Support Services provided by Polycom shall be substantially as described in applicable written materials provided to you by Polycom, and Polycom support engineers will make commercially reasonable efforts to solve any problem issues. Polycom does not warrant that your use of the Software Product will be uninterrupted or error free, or that all defects in the Software Product will be corrected. Polycom’s sole obligation under this express warranty shall be, at Polycom’s option and expense, to

refund the purchase price paid by you for any defective software product which is returned to Polycom with a copy of your receipt, or to replace any defective media with software which substantially conforms to applicable Polycom published specifications. Any replacement Software Product will be warranted for the remainder of the original warranty period or thirty (30) days, whichever is longer.

**6.2 Warranties Exclusive.** If this Software Product does not operate as warranted above, your sole remedy for breach of that warranty shall be repair, replacement, or refund of the purchase price paid, at Polycom's option. TO THE FULL EXTENT ALLOWED BY LAW, THE FOREGOING WARRANTIES AND REMEDIES ARE EXCLUSIVE AND ARE IN LIEU OF ALL OTHER WARRANTIES, TERMS OR CONDITIONS, EXPRESS OR IMPLIED, EITHER IN FACT OR BY OPERATION OF LAW, STATUTORY OR OTHERWISE, INCLUDING WARRANTIES, TERMS OR CONDITIONS OF MERCHANTABILITY, FITNESS FOR A PARTICULAR PURPOSE, SATISFACTORY QUALITY, CORRESPONDENCE WITH DESCRIPTION, AND NON-INFRINGEMENT, ALL OF WHICH ARE EXPRESSLY DISCLAIMED. POLYCOM NEITHER ASSUMES NOR AUTHORIZES ANY OTHER PERSON TO ASSUME FOR IT ANY OTHER LIABILITY IN CONNECTION WITH THE SALE, INSTALLATION, MAINTENANCE, OR USE OF THIS SOFTWARE PRODUCT.

POLYCOM SHALL NOT BE LIABLE UNDER THIS WARRANTY IF ITS TESTING AND EXAMINATION DISCLOSE THAT THE ALLEGED DEFECT OR MALFUNCTION IN THE SOFTWARE PRODUCT DOES NOT EXIST OR WAS CAUSED BY YOUR OR ANY THIRD PERSON'S MISUSE, NEGLIGENCE, IMPROPER INSTALLATION OR TESTING, UNAUTHORIZED ATTEMPTS TO MODIFY THE PRODUCT, OR ANY OTHER CAUSE BEYOND THE RANGE OF THE INTENDED USE, OR BY ACCIDENT, FIRE, LIGHTNING, POWER CUTS OR OUTAGES, OTHER HAZARDS, OR ACTS OF GOD.

## **7. LIMITATION OF LIABILITY.**

TO THE MAXIMUM EXTENT PERMITTED BY APPLICABLE LAW, IN NO EVENT SHALL POLYCOM OR ITS SUPPLIERS BE LIABLE FOR ANY SPECIAL, INCIDENTAL, INDIRECT, OR CONSEQUENTIAL DAMAGES WHATSOEVER (INCLUDING, WITHOUT LIMITATION, DAMAGES FOR LOSS OF BUSINESS PROFITS, BUSINESS INTERRUPTION, LOSS OF BUSINESS INFORMATION, OR ANY OTHER PECUNIARY LOSS) ARISING OUT OF THE USE OR INABILITY TO USE THE SOFTWARE PRODUCT OR THE PROVISION OF OR FAILURE TO PROVIDE SUPPORT SERVICES, EVEN IF POLYCOM HAS BEEN ADVISED OF THE POSSIBILITY OF SUCH DAMAGES. IN ANY CASE, POLYCOM'S ENTIRE LIABILITY SHALL BE LIMITED TO THE GREATER OF THE AMOUNT ACTUALLY PAID BY YOU FOR THE SOFTWARE PRODUCT OR U.S. \$5.00; PROVIDED, HOWEVER, IF YOU HAVE ENTERED INTO A POLYCOM SUPPORT SERVICES AGREEMENT, POLYCOM'S ENTIRE LIABILITY REGARDING SUPPORT SERVICES SHALL BE GOVERNED BY THE TERMS OF THAT AGREEMENT.

## **8. DISCLAIMER.**

Some countries, states, or provinces do not allow the exclusion or limitation of implied warranties or the limitation of incidental or consequential damages for certain products supplied to consumers, or the limitation of liability for personal injury, so the above limitations and exclusions may be limited in their application to you. When the implied warranties are not allowed to be excluded in their entirety, they will be limited to the duration of the applicable written warranty. This warranty gives you specific legal rights which may vary depending on local law.

## **9. EXPORT CONTROLS.**

The Software Product may not be downloaded or otherwise exported or re-exported (i) into (or to a national or resident of) Cuba, North Korea, Iran, Syria, Sudan, or any other country to which the U.S. has embargoed goods; or (ii) to anyone on the U.S. Treasury Department's List of Specially Designated Nationals or the U.S. Commerce Department's Table of Denial Orders. By downloading or using this Software Product, you are agreeing to the foregoing and you are representing and warranting that you are

not located in, under the control of, or a national or resident of any such country or on any such list. If you obtained this Software Product outside of the United States, you are also agreeing that you will not export or re-export it in violation of the laws of the country in which it was obtained.

## **10. MISCELLANEOUS.**

**10.1 Governing Law.** This Agreement shall be governed by the laws of the State of California, as such laws are applied to agreements entered into and to be performed entirely within California between California residents, and by the laws of the United States. The United Nations Convention on Contracts for the International Sale of Goods (1980) is hereby excluded in its entirety from application to this Agreement.

**10.2 General.** This Agreement represents the complete agreement concerning this license and may amended only by a writing executed by both parties. If any provision of this Agreement is held to be unenforceable, such provision shall be reformed only to the extent necessary to make it enforceable.

**10.3 Contact.** If you have any questions concerning this Agreement, or if you desire to contact Polycom for any reason, please contact the Polycom office serving your country.

**10.4 U.S. Government Restricted Rights.** The software and documentation provided by Polycom pursuant to this Agreement are "Commercial Items," as the term is defined at 48 C.F.R. §2.101, consisting of "Commercial Computer Software" and "Commercial Computer Software Documentation," as such terms are used in 48 C.F.R. §12.212 or 48 C.F.R. §227.7202, as applicable. Consistent with 48 C.F.R. §12.212 or 48 C.F.R. §§227.7202-1 through 227.7202-4, as applicable, the Commercial Computer Software and Commercial Computer Software Documentation are licensed to United States Government end users (1) only as Commercial Items and (2) with only those rights as are granted to all other users pursuant to the terms of this Agreement.

[www.polycom.com](http://www.polycom.com)

**Corporate Headquarters:** 4750 Willow Road, Pleasanton, CA 94588,  
USA  
Phone: 925.924.6000

**Israel Office:** 94 Derech Em Hamoshavot P.O.B. 3654,  
Petach-Tikva 49130, Israel  
Phone: +972 3 925 1444  
Fax: +972 3 921 1571

**Netherlands Office:** Tarnspolis Park, Siriusdreef 41, 2132 Wt  
Hoofddorp Netherlands  
Phone: 31-0-230-2600